

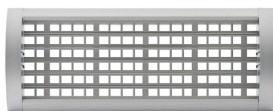

SUPPLY GRILLE FOR CIRCULAR DUCT

UDC
SERIES



OVERVIEW

FEATURES

The UDC grilles, specially designed for installation on a circular ducts, is characterized by the realization of the profile in a single natural anodised extruded aluminum body, with a shaped front profile, horizontal and vertical drop-shaped wings individually adjustable, in extruded aluminum natural anodised.

Its particular geometry and adjustable heads, made of anti-static ABS class 1 with high flexibility, allow adaptation to any diameter of duct.

The original design of the profile also makes it possible to install a sliding calibration damper or a pick-up damper without changing the overall dimensions.

VERSIONS

The UDC grille is made in the version with two rows of horizontal and vertical fins and in the version with only one row of horizontal fins.

ACCESSORIES

Sliding calibration damper, pick-up damper.

INSTALLATION

Quick fitting on duct.

UNSUITABLE ENVIRONMENTS

The aluminum products are not suitable for installation in environments with an atmosphere containing corrosive substances for this material and in particular containing chlorine, such as swimming pools, spas and some types of food industries.

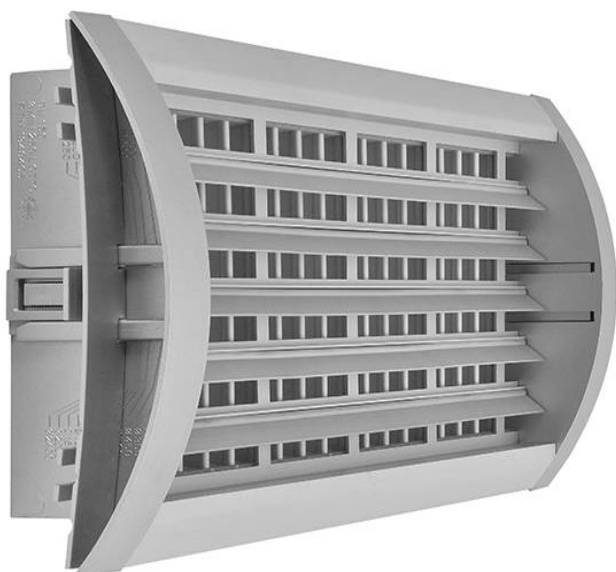
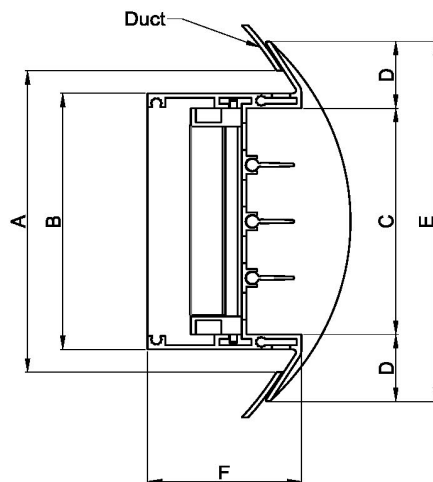

| Overall Dimensions | | | |
|--------------------|--------|-----|------|
| Size | Height | | |
| | 100 | 150 | 200 |
| A | 100 | 150 | 200 |
| B | 85 | 140 | 185 |
| C | 75 | 130 | 173 |
| D | 22 | 20 | 21,5 |
| E | 119 | 170 | 216 |
| F | 48 | 48 | 49 |

| Effective area Ak [m ²] | | | |
|-------------------------------------|--------|-------|-------|
| L | Height | | |
| | 100 | 150 | 200 |
| 200 | 0,015 | 0,026 | 0,036 |
| 300 | 0,023 | 0,039 | 0,052 |
| 400 | 0,030 | 0,052 | 0,069 |
| 500 | 0,038 | 0,065 | 0,086 |
| 600 | 0,045 | 0,078 | 0,104 |
| 800 | 0,060 | 0,104 | 0,138 |
| 1000 | 0,075 | 0,130 | 0,173 |

L Nomnal length
Opening in the duct: AxL

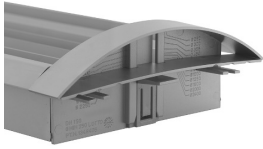

SUPPLY GRILLE FOR CIRCULAR DUCT

UDC
SERIES

UDC 100-200
PERFORMANCE

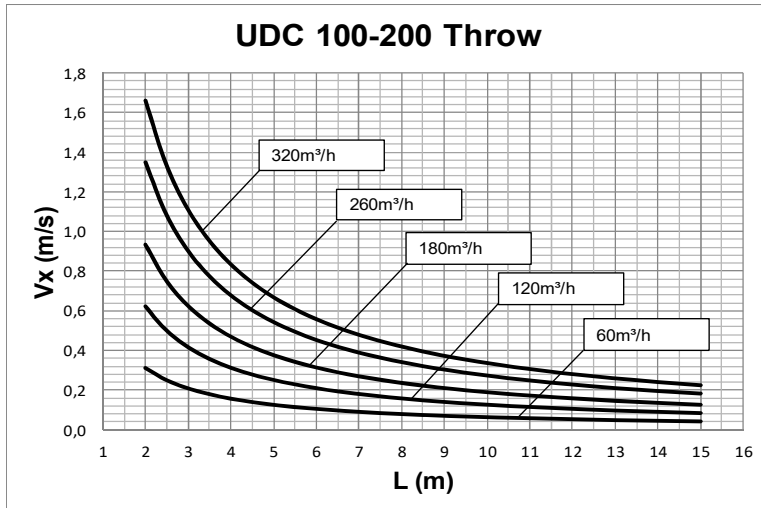

Values measured in isothermic conditions with horizontal blades in accordance with the following international standard:

ISO 5219 1984: *Air distribution and air diffusion - Laboratory. Aerodynamic testing and rating of air terminal devices.*

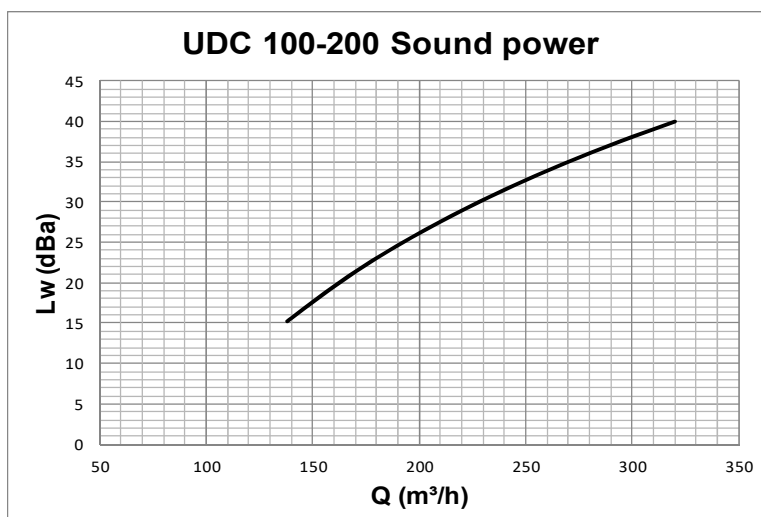
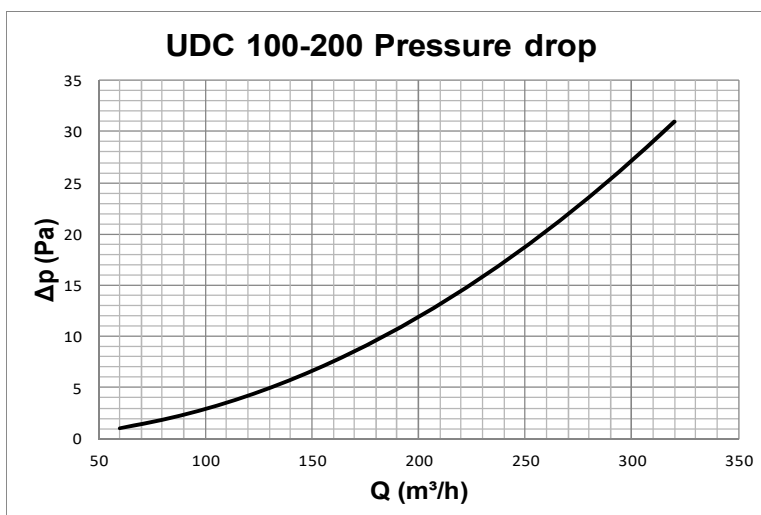

Data measured in reverberation room in accordance with international standards:
ISO 3741 1999: *Acoustic - determination of sound power levels of noise sources using sound pressure - Precision methods for reverberation rooms*
ISO 5135 1997: *Acoustic - determination of sound power levels of noise from air-terminal devices; air terminal units; dampers and valves by measurement in a reverberation room.*

The shown data does not take into consideration the attenuation resulting from the surroundings where the diffuser is installed. Such attenuation is normally included between 6 and 10 dBa and is determined by the size of the surrounding space, its shape and the characteristics of the furniture and room fittings.

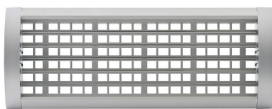

SUPPLY GRILLE FOR CIRCULAR DUCT

UDC
SERIES

UDC 100-300 PERFORMANCE

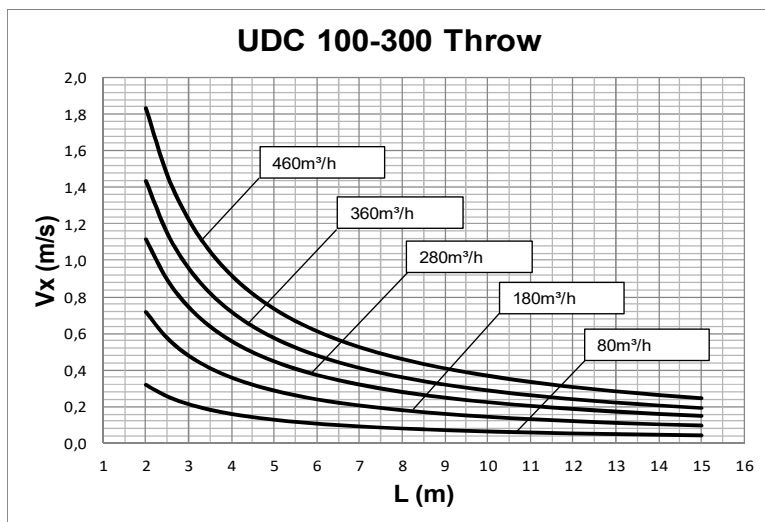

Values measured in isothermic conditions with horizontal blades in accordance with the following international standard:

ISO 5219 1984: *Air distribution and air diffusion - Laboratory. Aerodynamic testing and rating of air terminal devices.*

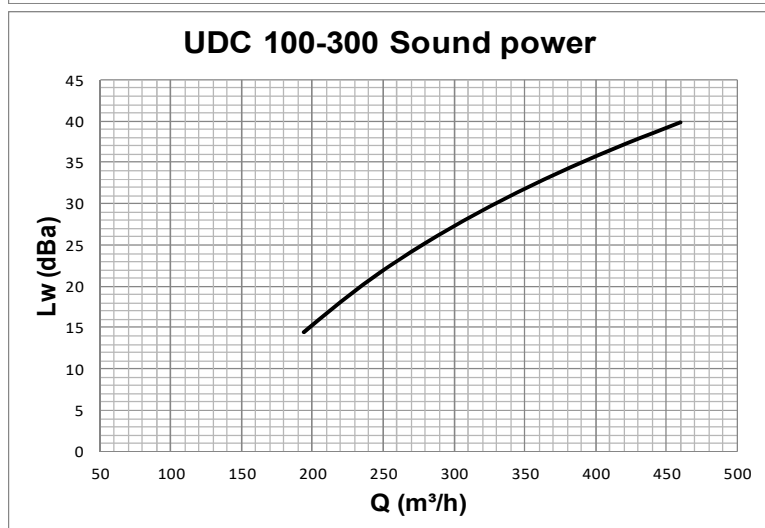
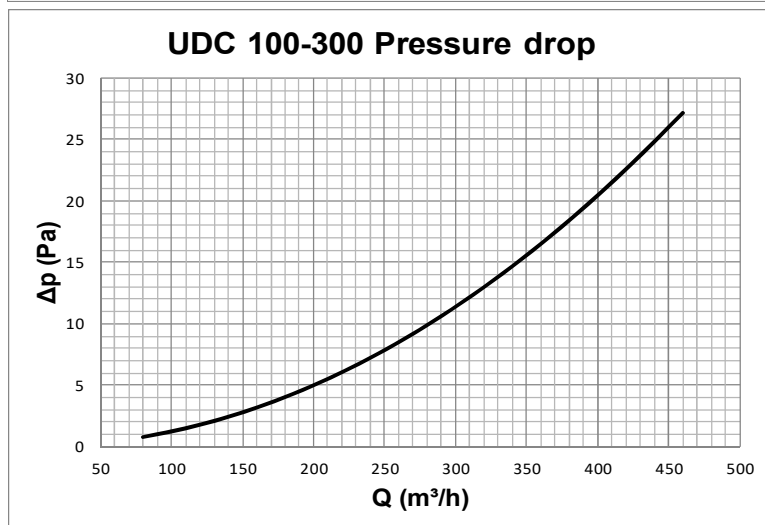

Data measured in reverberation room in accordance with international standards:
ISO 3741 1999: *Acoustic - determination of sound power levels of noise sources using sound pressure - Precision methods for reverberation rooms*
ISO 5135 1997: *Acoustic - determination of sound power levels of noise from air-terminal devices; air terminal units; dampers and valves by measurement in a reverberation room.*

The shown data does not take into consideration the attenuation resulting from the surroundings where the diffuser is installed. Such attenuation is normally included between 6 and 10 dBa and is determined by the size of the surrounding space, its shape and the characteristics of the furniture and room fittings.

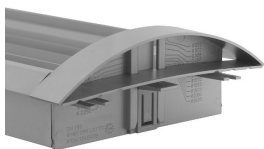

SUPPLY GRILLE FOR CIRCULAR DUCT

UDC
SERIES

UDC 100-400
PERFORMANCE

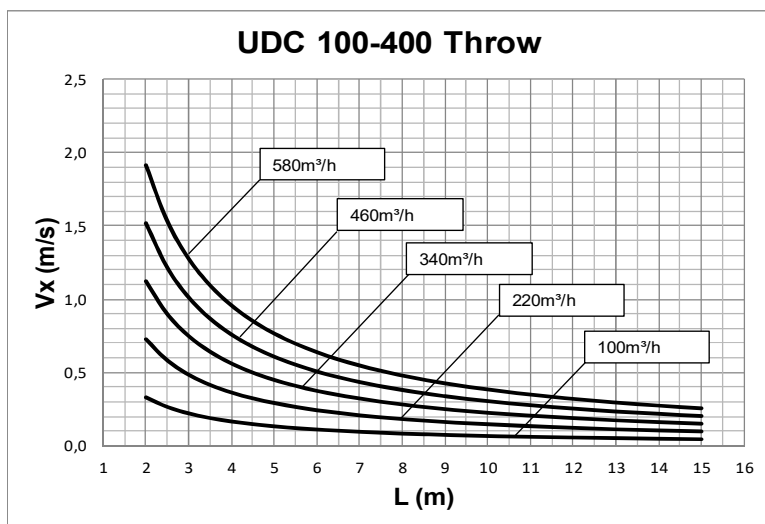

Values measured in isothermic conditions with horizontal blades in accordance with the following international standard:

ISO 5219 1984: *Air distribution and air diffusion - Laboratory. Aerodynamic testing and rating of air terminal devices.*

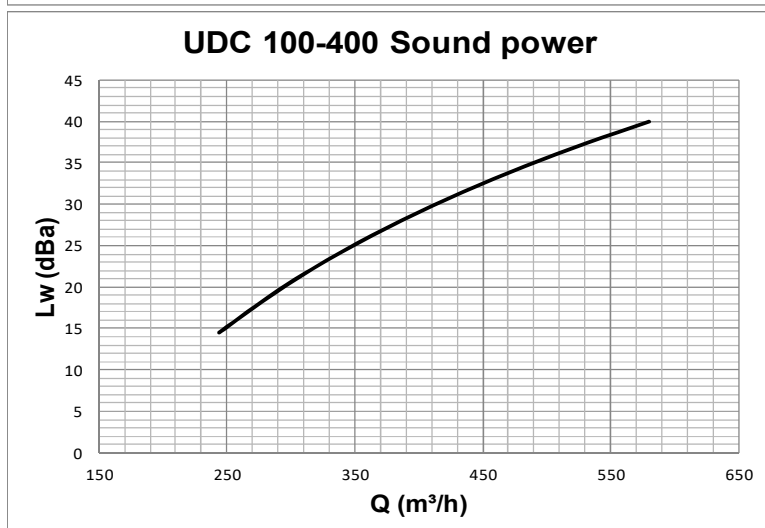
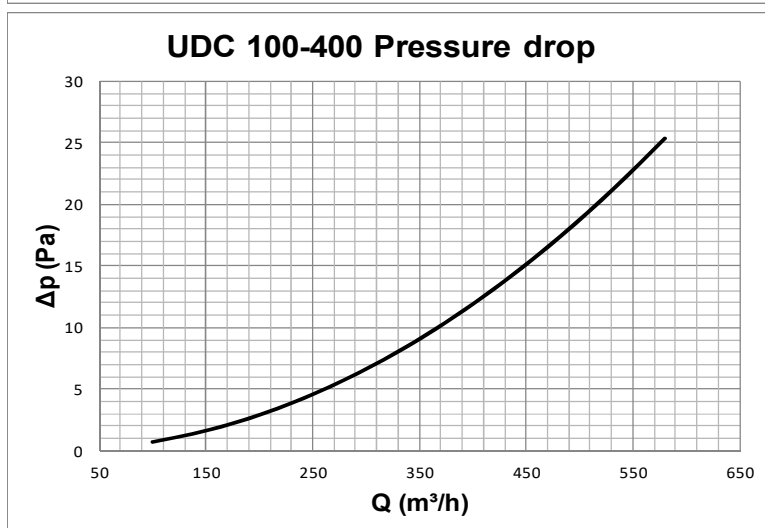

Data measured in reverberation room in accordance with international standards:
ISO 3741 1999: *Acoustic - determination of sound power levels of noise sources using sound pressure - Precision methods for reverberation rooms*
ISO 5135 1997: *Acoustic - determination of sound power levels of noise from air-terminal devices; air terminal units; dampers and valves by measurement in a reverberation room.*

The shown data does not take into consideration the attenuation resulting from the surroundings where the diffuser is installed. Such attenuation is normally included between 6 and 10 dBa and is determined by the size of the surrounding space, its shape and the characteristics of the furniture and room fittings.

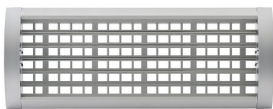

SUPPLY GRILLE FOR CIRCULAR DUCT

UDC
SERIES

UDC 100-500 PERFORMANCE

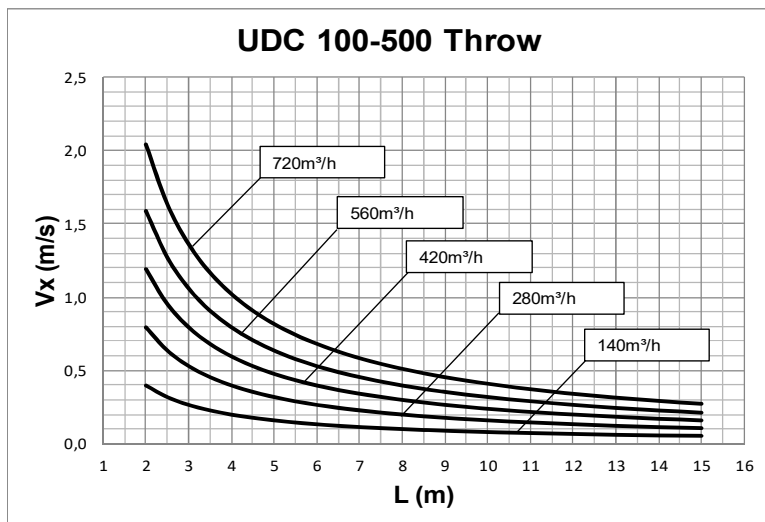

Values measured in isothermic conditions with horizontal blades in accordance with the following international standard:

ISO 5219 1984: *Air distribution and air diffusion - Laboratory. Aerodynamic testing and rating of air terminal devices.*

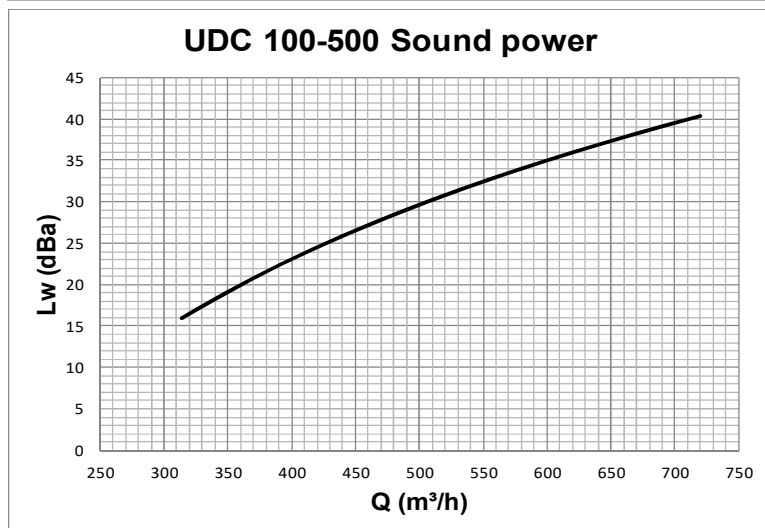
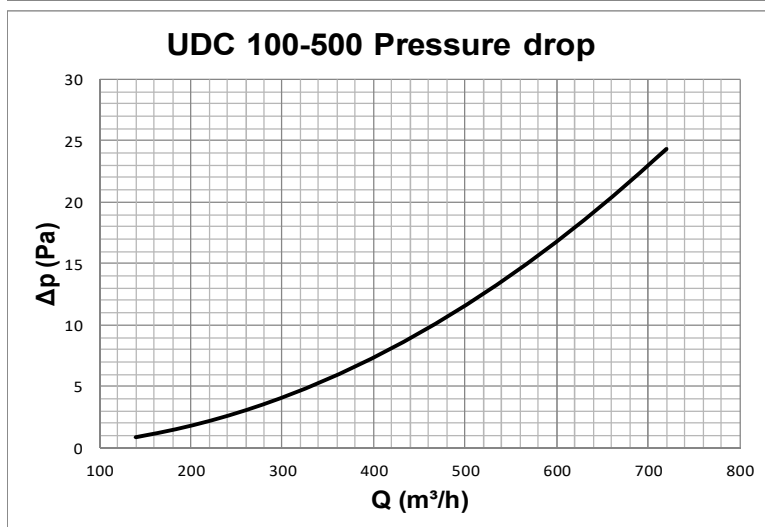

Data measured in reverberation room in accordance with international standards:
ISO 3741 1999: *Acoustic - determination of sound power levels of noise sources using sound pressure - Precision methods for reverberation rooms*
ISO 5135 1997: *Acoustic - determination of sound power levels of noise from air-terminal devices; air terminal units; dampers and valves by measurement in a reverberation room.*

The shown data does not take into consideration the attenuation resulting from the surroundings where the diffuser is installed. Such attenuation is normally included between 6 and 10 dBa and is determined by the size of the surrounding space, its shape and the characteristics of the furniture and room fittings.

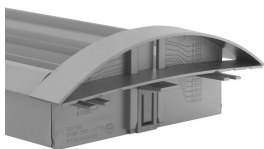

SUPPLY GRILLE FOR CIRCULAR DUCT

UDC
SERIES

UDC 100-600
PERFORMANCE

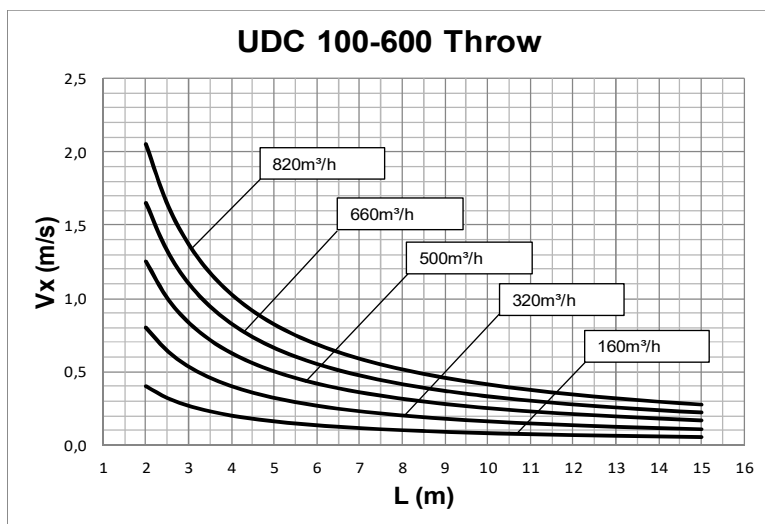

Values measured in isothermic conditions with horizontal blades in accordance with the following international standard:

ISO 5219 1984: *Air distribution and air diffusion - Laboratory. Aerodynamic testing and rating of air terminal devices.*

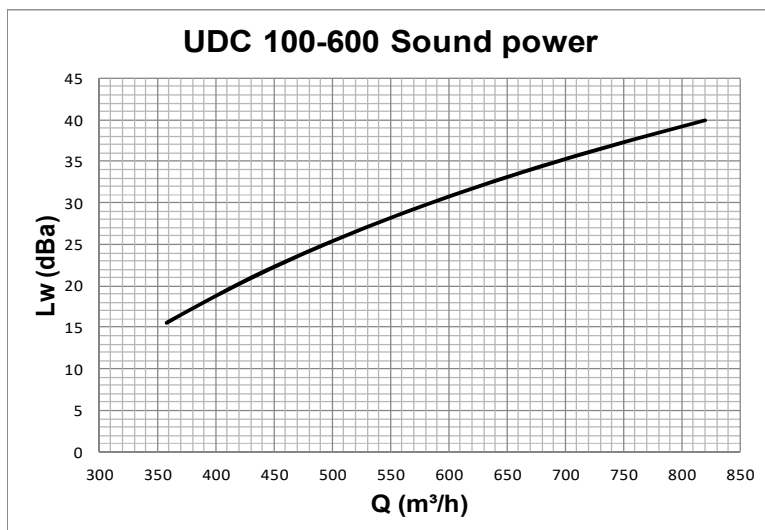
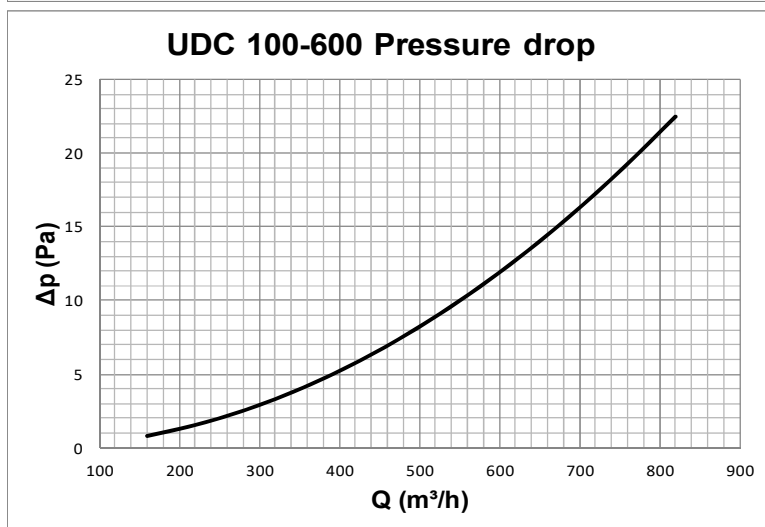

Data measured in reverberation room in accordance with international standards:
ISO 3741 1999: *Acoustic - determination of sound power levels of noise sources using sound pressure - Precision methods for reverberation rooms*
ISO 5135 1997: *Acoustic - determination of sound power levels of noise from air-terminal devices; air terminal units; dampers and valves by measurement in a reverberation room.*

The shown data does not take into consideration the attenuation resulting from the surroundings where the diffuser is installed. Such attenuation is normally included between 6 and 10 dBa and is determined by the size of the surrounding space, its shape and the characteristics of the furniture and room fittings.

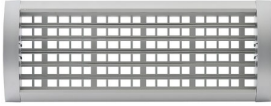

SUPPLY GRILLE FOR CIRCULAR DUCT

UDC
SERIES

UDC 100-800
PERFORMANCE

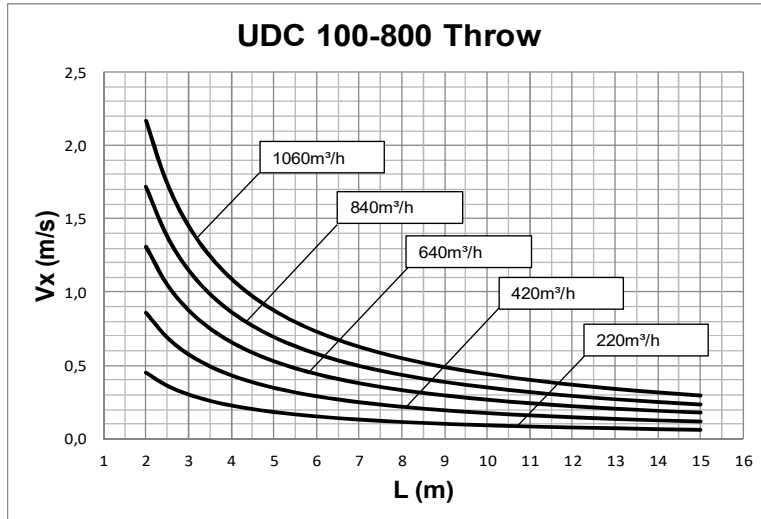

Values measured in isothermic conditions with horizontal blades in accordance with the following international standard:

ISO 5219 1984: *Air distribution and air diffusion - Laboratory. Aerodynamic testing and rating of air terminal devices.*

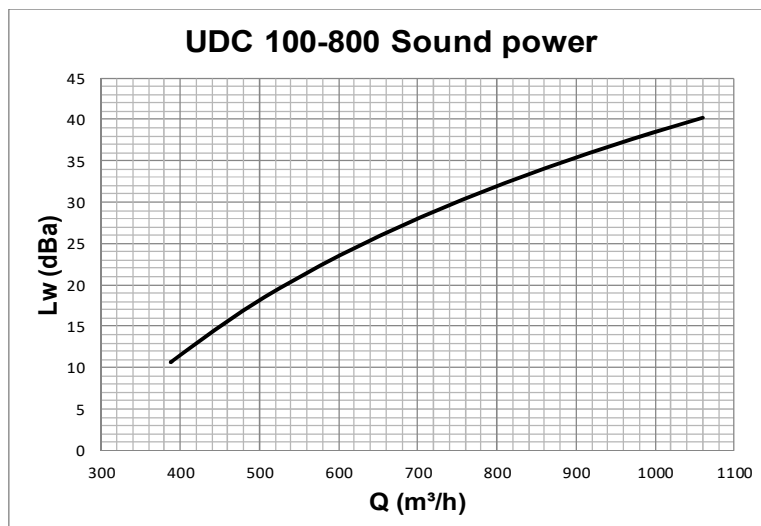
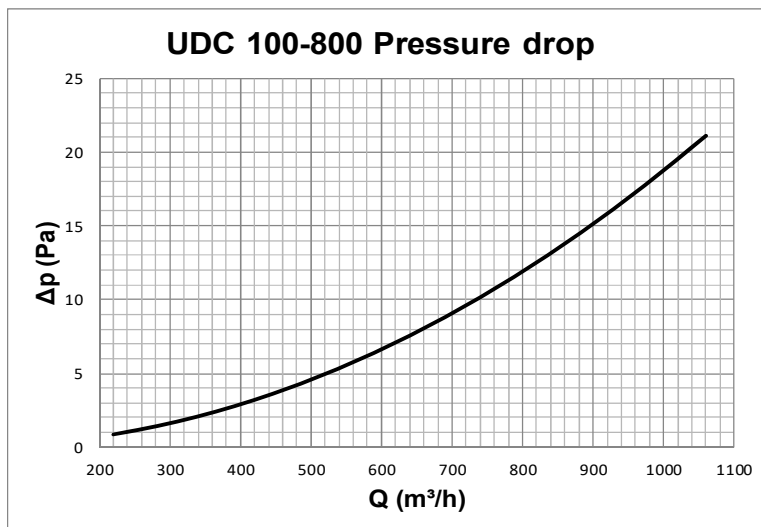

Data measured in reverberation room in accordance with international standards:
ISO 3741 1999: *Acoustic - determination of sound power levels of noise sources using sound pressure - Precision methods for reverberation rooms*
ISO 5135 1997: *Acoustic - determination of sound power levels of noise from air-terminal devices; air terminal units; dampers and valves by measurement in a reverberation room.*

The shown data does not take into consideration the attenuation resulting from the surroundings where the diffuser is installed. Such attenuation is normally included between 6 and 10 dBa and is determined by the size of the surrounding space, its shape and the characteristics of the furniture and room fittings.

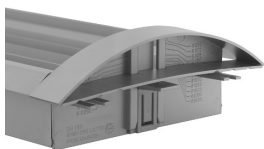

SUPPLY GRILLE FOR CIRCULAR DUCT

UDC SERIES

UDC 100-1000 PERFORMANCE

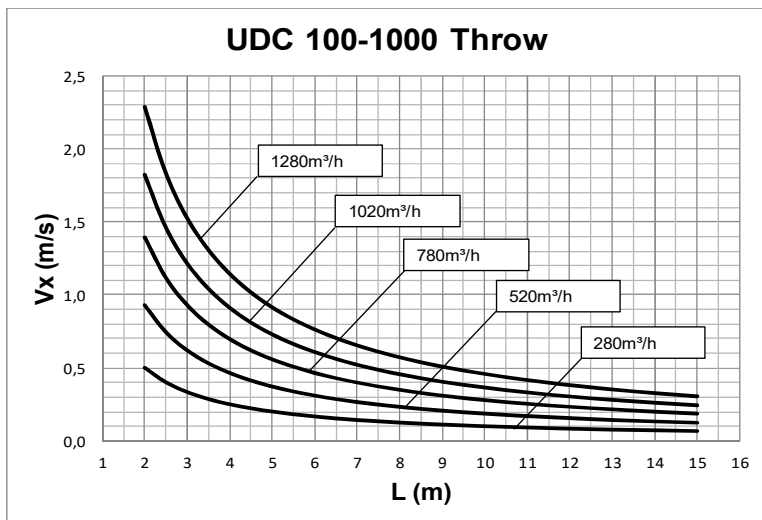

Values measured in isothermic conditions with horizontal blades in accordance with the following international standard:

ISO 5219 1984: *Air distribution and air diffusion - Laboratory. Aerodynamic testing and rating of air terminal devices.*

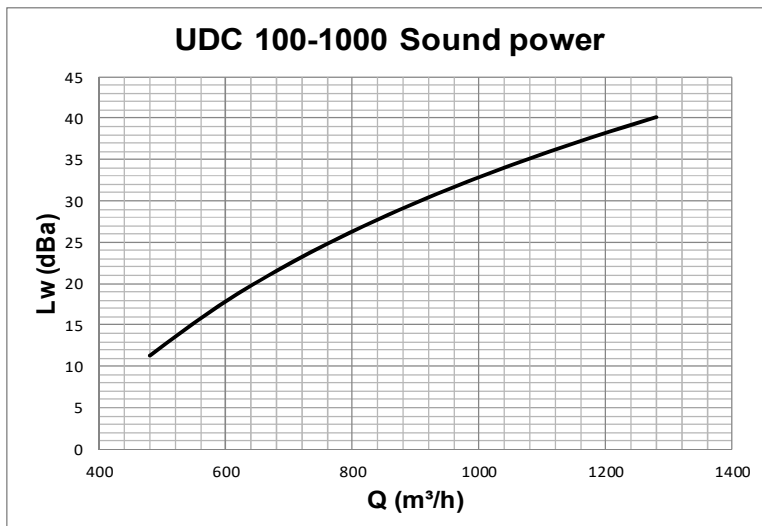
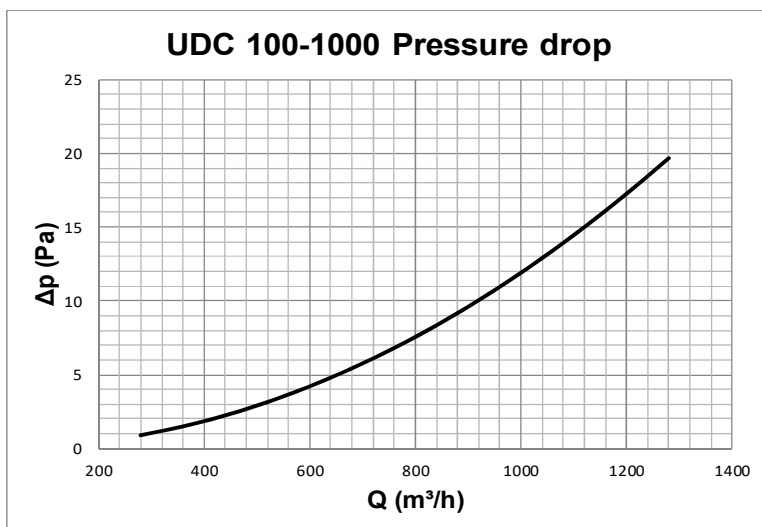

Data measured in reverberation room in accordance with international standards: ISO 3741 1999: *Acoustic - determination of sound power levels of noise sources using sound pressure - Precision methods for reverberation rooms* ISO 5135 1997: *Acoustic - determination of sound power levels of noise from air-terminal devices; air terminal units; dampers and valves by measurement in a reverberation room.*

The shown data does not take into consideration the attenuation resulting from the surroundings where the diffuser is installed. Such attenuation is normally included between 6 and 10 dBa and is determined by the size of the surrounding space, its shape and the characteristics of the furniture and room fittings.

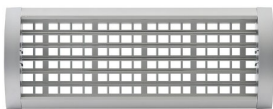

SUPPLY GRILLE FOR CIRCULAR DUCT

UDC
SERIES

UDC 150-200 PERFORMANCE

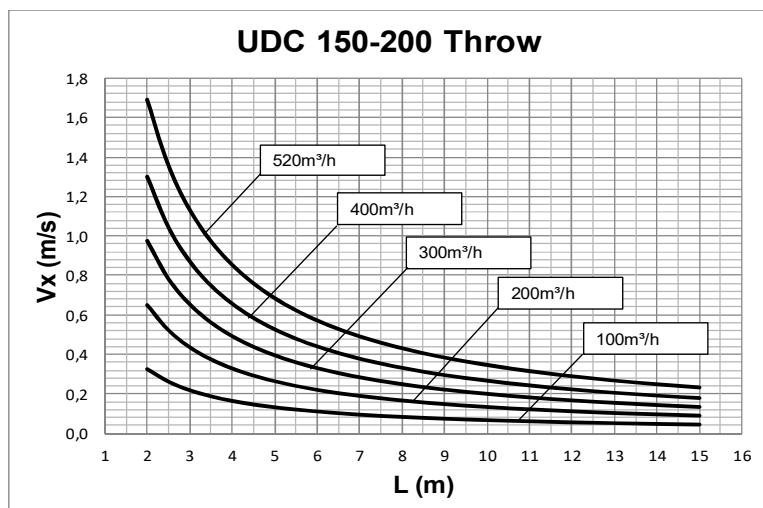

Values measured in isothermic conditions with horizontal blades in accordance with the following international standard:

ISO 5219 1984: *Air distribution and air diffusion - Laboratory. Aerodynamic testing and rating of air terminal devices.*

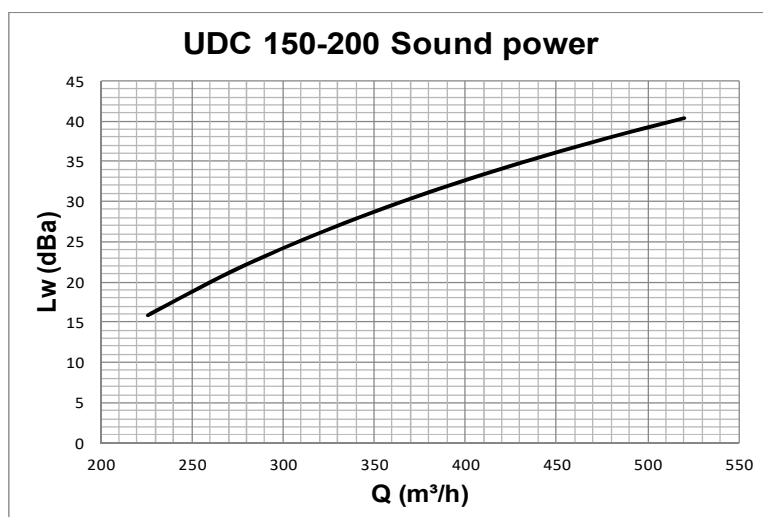
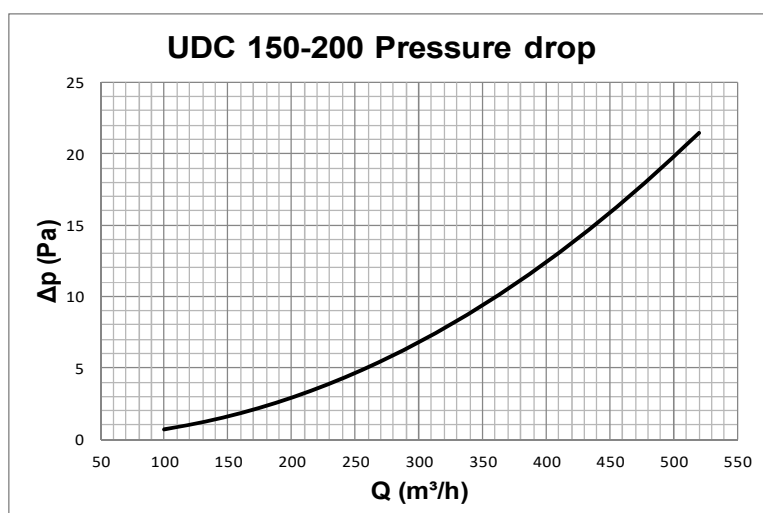

Data measured in reverberation room in accordance with international standards:
ISO 3741 1999: *Acoustic - determination of sound power levels of noise sources using sound pressure - Precision methods for reverberation rooms*
ISO 5135 1997: *Acoustic - determination of sound power levels of noise from air-terminal devices; air terminal units; dampers and valves by measurement in a reverberation room.*

The shown data does not take into consideration the attenuation resulting from the surroundings where the diffuser is installed. Such attenuation is normally included between 6 and 10 dBa and is determined by the size of the surrounding space, its shape and the characteristics of the furniture and room fittings.

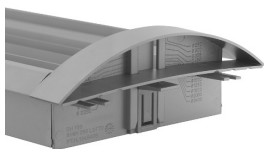

SUPPLY GRILLE FOR CIRCULAR DUCT

UDC SERIES

UDC 150-300 PERFORMANCE

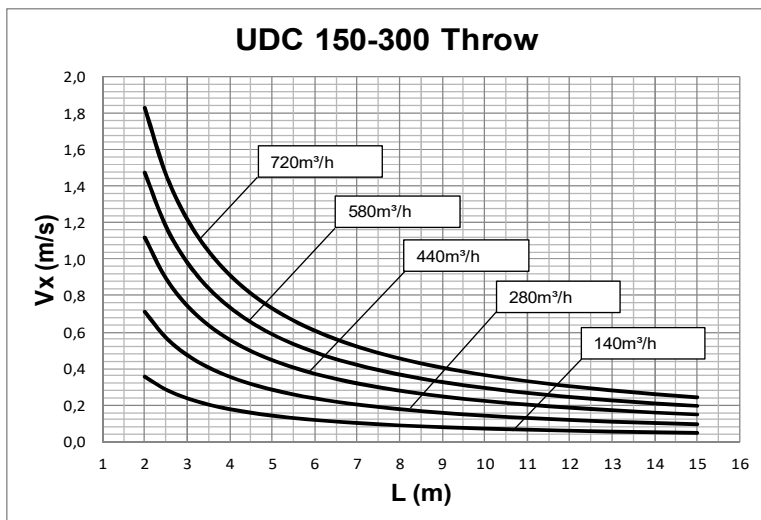

Values measured in isothermic conditions with horizontal blades in accordance with the following international standard:

ISO 5219 1984: *Air distribution and air diffusion - Laboratory. Aerodynamic testing and rating of air terminal devices.*

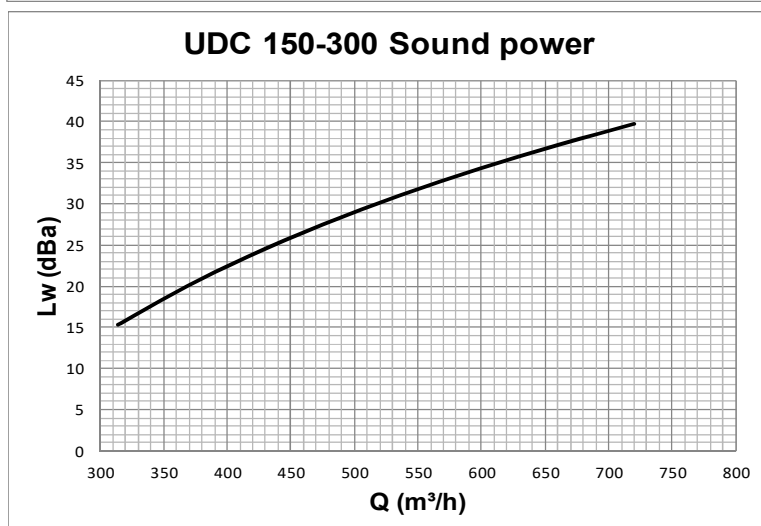
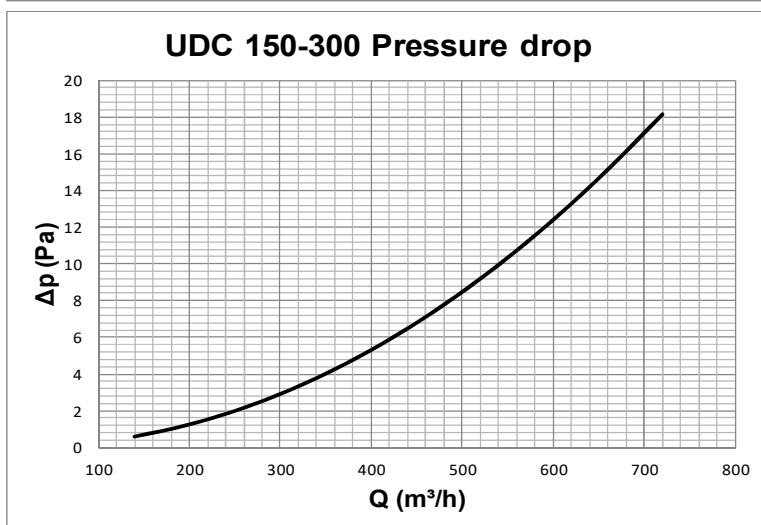

Data measured in reverberation room in accordance with international standards:
ISO 3741 1999: *Acoustic - determination of sound power levels of noise sources using sound pressure - Precision methods for reverberation rooms*
ISO 5135 1997: *Acoustic - determination of sound power levels of noise from air-terminal devices; air terminal units; dampers and valves by measurement in a reverberation room.*

The shown data does not take into consideration the attenuation resulting from the surroundings where the diffuser is installed. Such attenuation is normally included between 6 and 10 dBa and is determined by the size of the surrounding space, its shape and the characteristics of the furniture and room fittings.

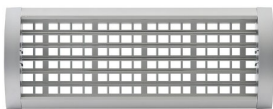

SUPPLY GRILLE FOR CIRCULAR DUCT

UDC SERIES

UDC 150-400 PERFORMANCE

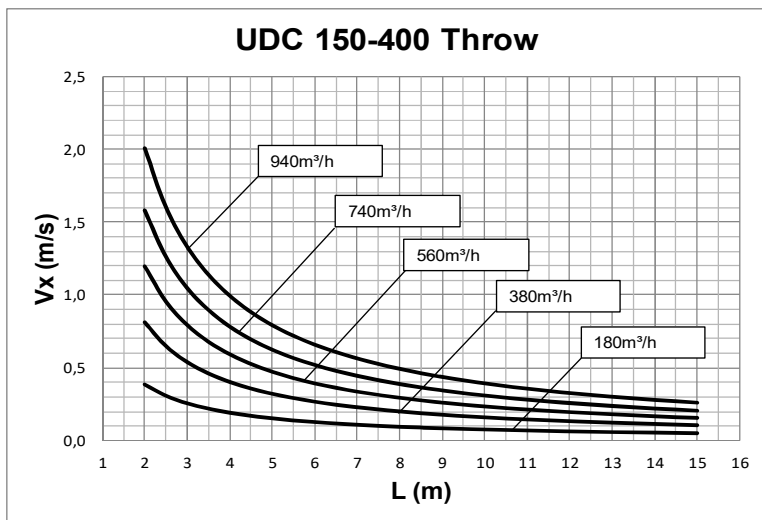

Values measured in isothermic conditions with horizontal blades in accordance with the following international standard:

ISO 5219 1984: *Air distribution and air diffusion - Laboratory. Aerodynamic testing and rating of air terminal devices.*

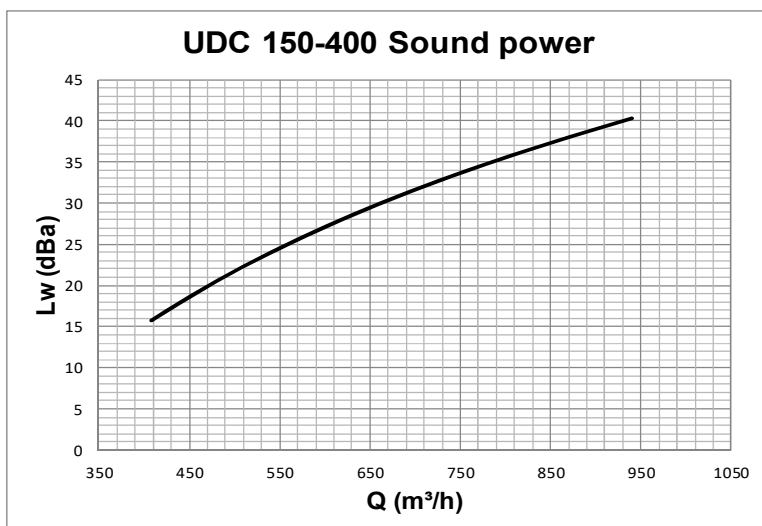
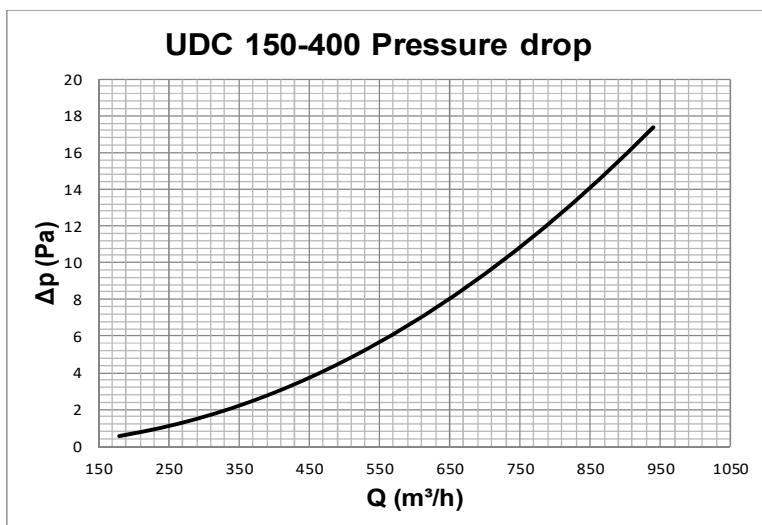

Data measured in reverberation room in accordance with international standards:
ISO 3741 1999: *Acoustic - determination of sound power levels of noise sources using sound pressure - Precision methods for reverberation rooms*
ISO 5135 1997: *Acoustic - determination of sound power levels of noise from air-terminal devices; air terminal units; dampers and valves by measurement in a reverberation room.*

The shown data does not take into consideration the attenuation resulting from the surroundings where the diffuser is installed. Such attenuation is normally included between 6 and 10 dBa and is determined by the size of the surrounding space, its shape and the characteristics of the furniture and room fittings.

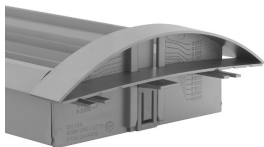

SUPPLY GRILLE FOR CIRCULAR DUCT

UDC
SERIES

UDC 150-500 PERFORMANCE

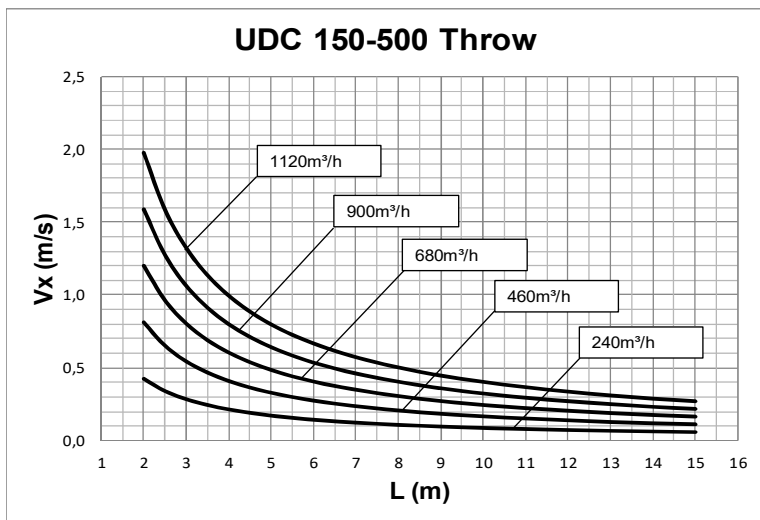

Values measured in isothermic conditions with horizontal blades in accordance with the following international standard:

ISO 5219 1984: *Air distribution and air diffusion - Laboratory. Aerodynamic testing and rating of air terminal devices.*

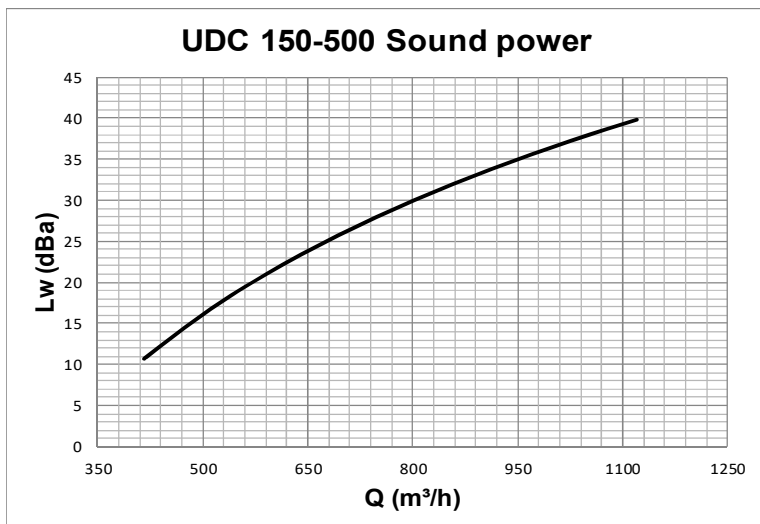
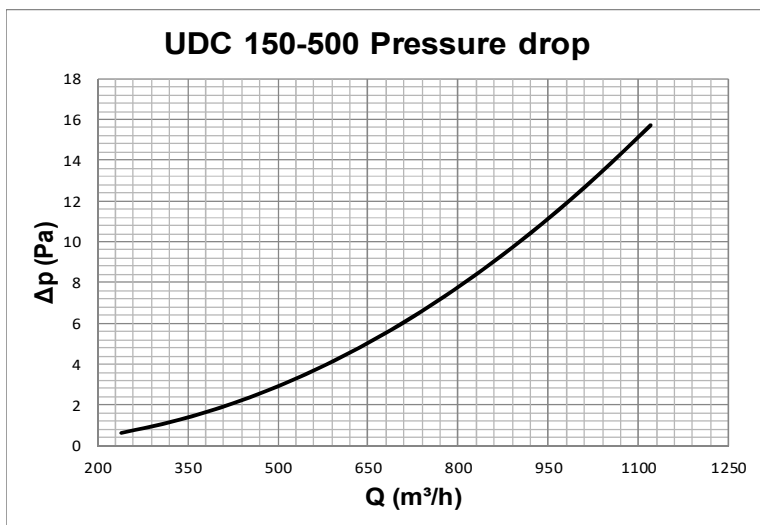

Data measured in reverberation room in accordance with international standards:
ISO 3741 1999: *Acoustic - determination of sound power levels of noise sources using sound pressure - Precision methods for reverberation rooms*
ISO 5135 1997: *Acoustic - determination of sound power levels of noise from air-terminal devices; air terminal units; dampers and valves by measurement in a reverberation room.*

The shown data does not take into consideration the attenuation resulting from the surroundings where the diffuser is installed. Such attenuation is normally included between 6 and 10 dBa and is determined by the size of the surrounding space, its shape and the characteristics of the furniture and room fittings.

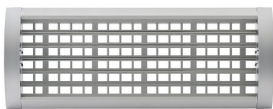

SUPPLY GRILLE FOR CIRCULAR DUCT

UDC
SERIES

UDC 150-600
PERFORMANCE

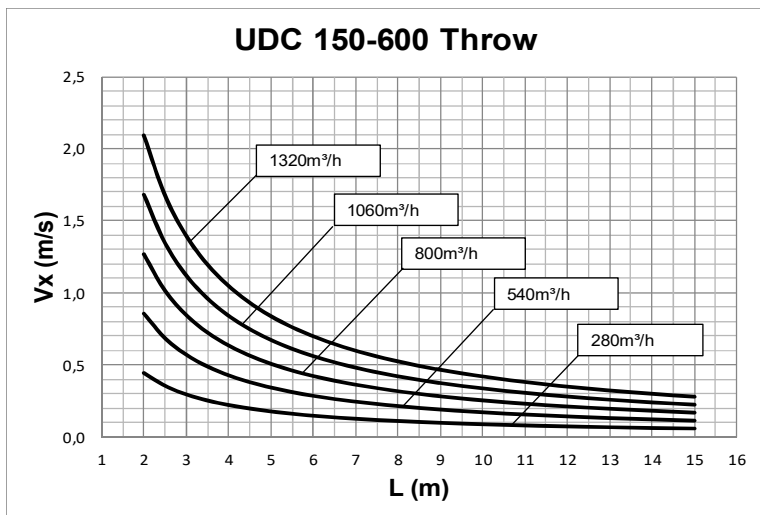

Values measured in isothermic conditions with horizontal blades in accordance with the following international standard:

ISO 5219 1984: *Air distribution and air diffusion - Laboratory. Aerodynamic testing and rating of air terminal devices.*

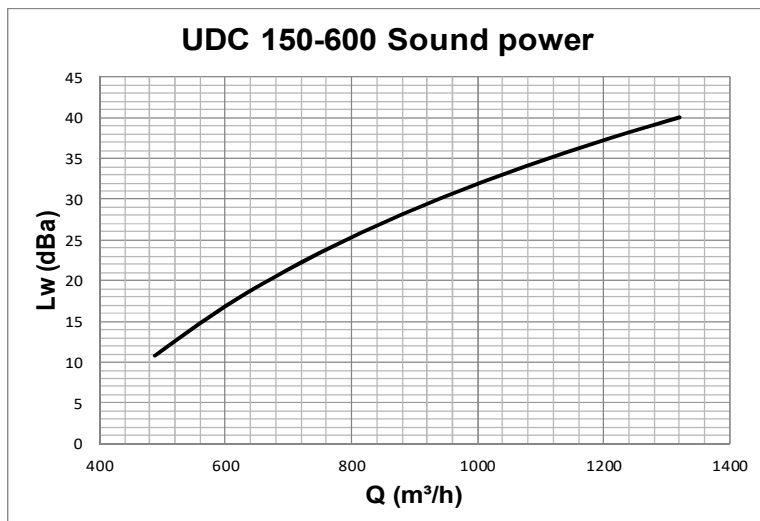
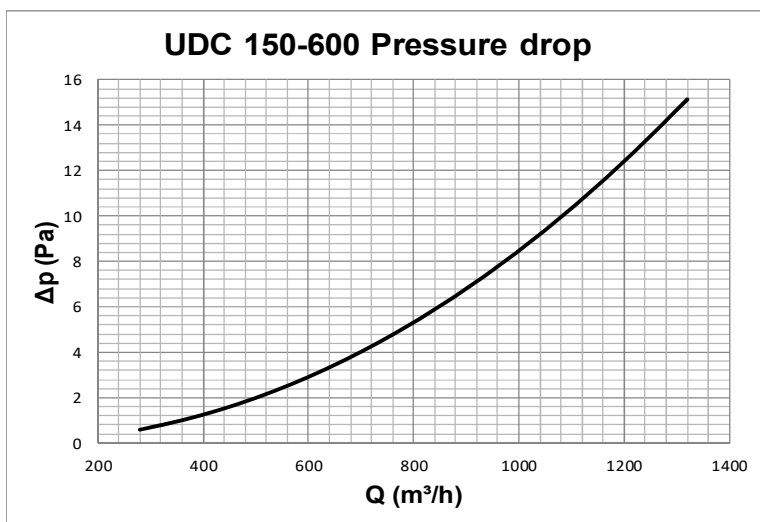

Data measured in reverberation room in accordance with international standards:
ISO 3741 1999: *Acoustic - determination of sound power levels of noise sources using sound pressure - Precision methods for reverberation rooms*
ISO 5135 1997: *Acoustic - determination of sound power levels of noise from air-terminal devices; air terminal units; dampers and valves by measurement in a reverberation room.*

The shown data does not take into consideration the attenuation resulting from the surroundings where the diffuser is installed. Such attenuation is normally included between 6 and 10 dBa and is determined by the size of the surrounding space, its shape and the characteristics of the furniture and room fittings.

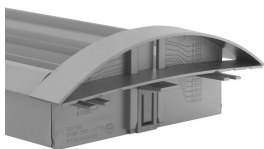

SUPPLY GRILLE FOR CIRCULAR DUCT

UDC SERIES

UDC 150-800 PERFORMANCE

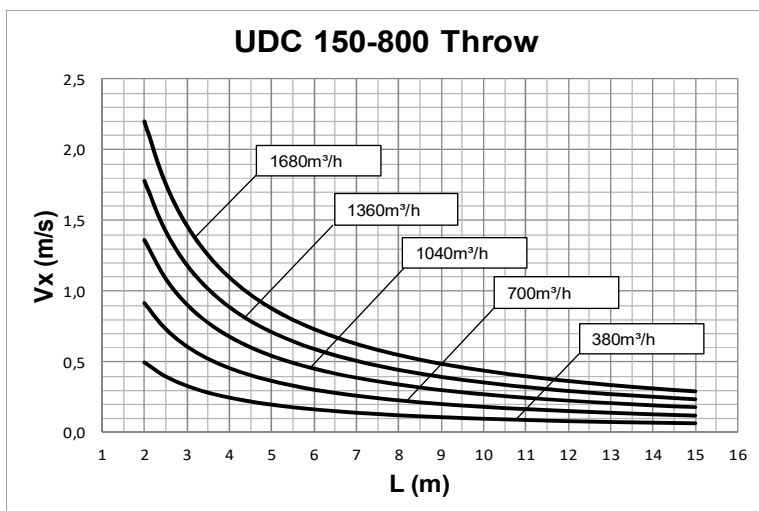

Values measured in isothermic conditions with horizontal blades in accordance with the following international standard:

ISO 5219 1984: *Air distribution and air diffusion - Laboratory. Aerodynamic testing and rating of air terminal devices.*

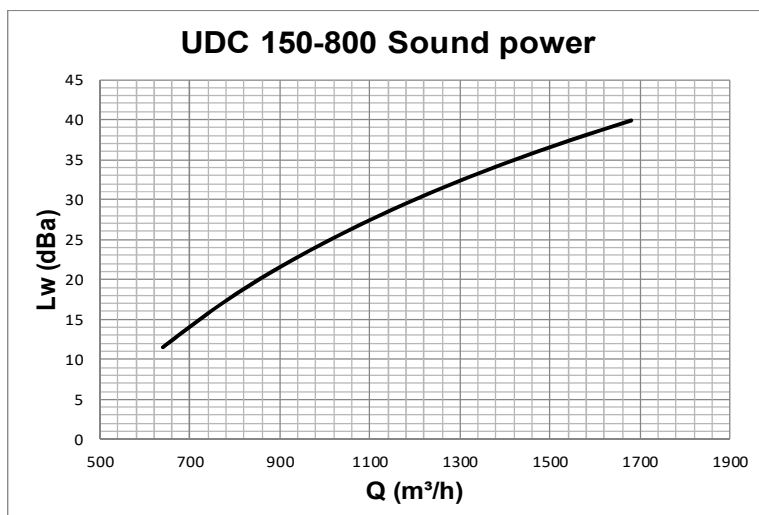
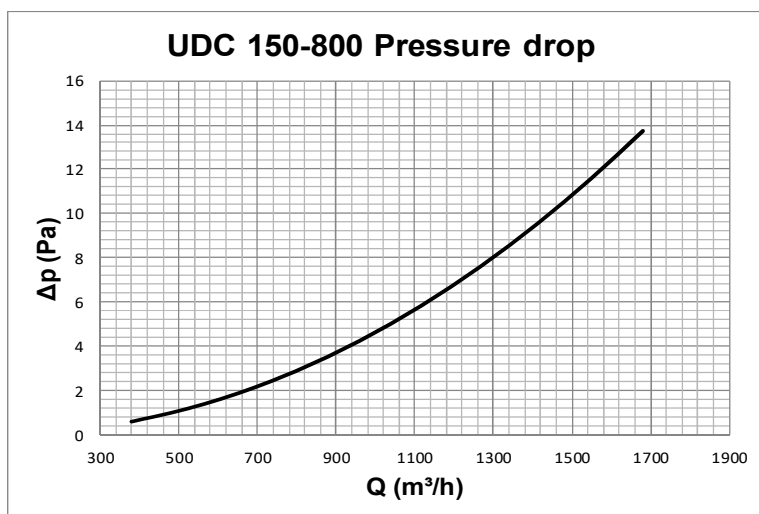

Data measured in reverberation room in accordance with international standards:
ISO 3741 1999: *Acoustic - determination of sound power levels of noise sources using sound pressure - Precision methods for reverberation rooms*
ISO 5135 1997: *Acoustic - determination of sound power levels of noise from air-terminal devices; air terminal units; dampers and valves by measurement in a reverberation room.*

The shown data does not take into consideration the attenuation resulting from the surroundings where the diffuser is installed. Such attenuation is normally included between 6 and 10 dBa and is determined by the size of the surrounding space, its shape and the characteristics of the furniture and room fittings.

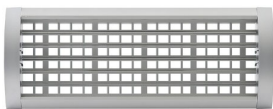

SUPPLY GRILLE FOR CIRCULAR DUCT

UDC
SERIES

UDC 150-1000
PERFORMANCE

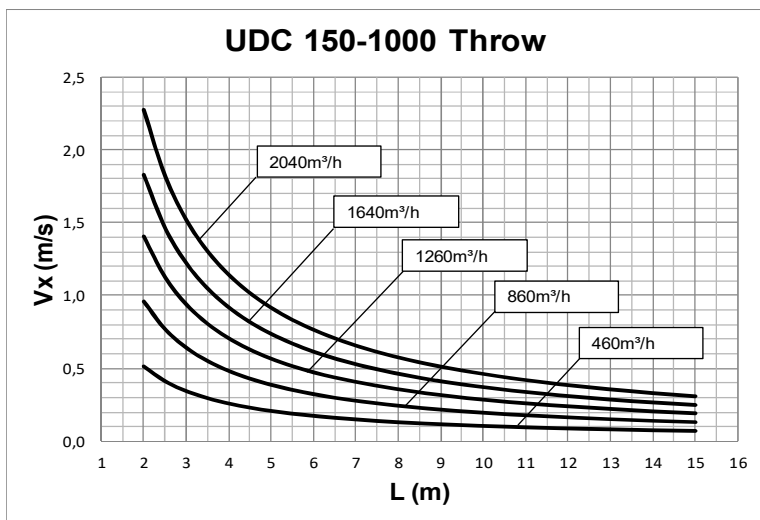

Values measured in isothermic conditions with horizontal blades in accordance with the following international standard:

ISO 5219 1984: *Air distribution and air diffusion - Laboratory. Aerodynamic testing and rating of air terminal devices.*

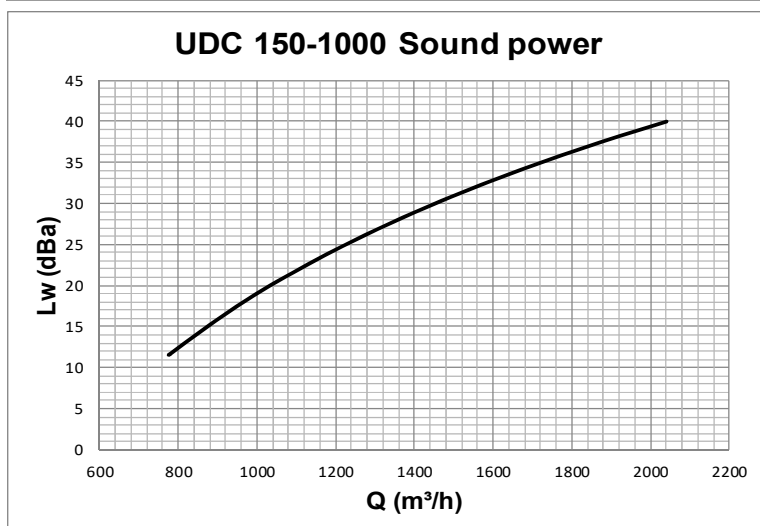
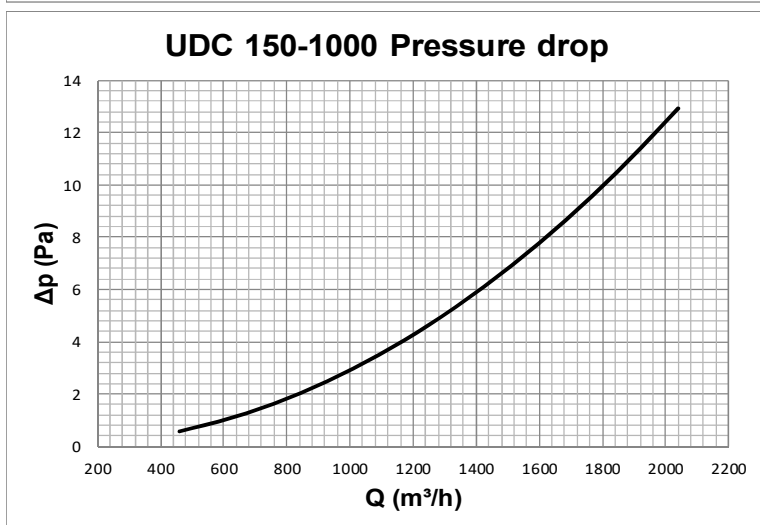

Data measured in reverberation room in accordance with international standards:
ISO 3741 1999: *Acoustic - determination of sound power levels of noise sources using sound pressure - Precision methods for reverberation rooms*
ISO 5135 1997: *Acoustic - determination of sound power levels of noise from air-terminal devices; air terminal units; dampers and valves by measurement in a reverberation room.*

The shown data does not take into consideration the attenuation resulting from the surroundings where the diffuser is installed. Such attenuation is normally included between 6 and 10 dBa and is determined by the size of the surrounding space, its shape and the characteristics of the furniture and room fittings.

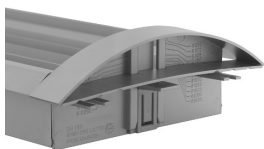

SUPPLY GRILLE FOR CIRCULAR DUCT

UDC
SERIES

UDC 200-200
PERFORMANCE

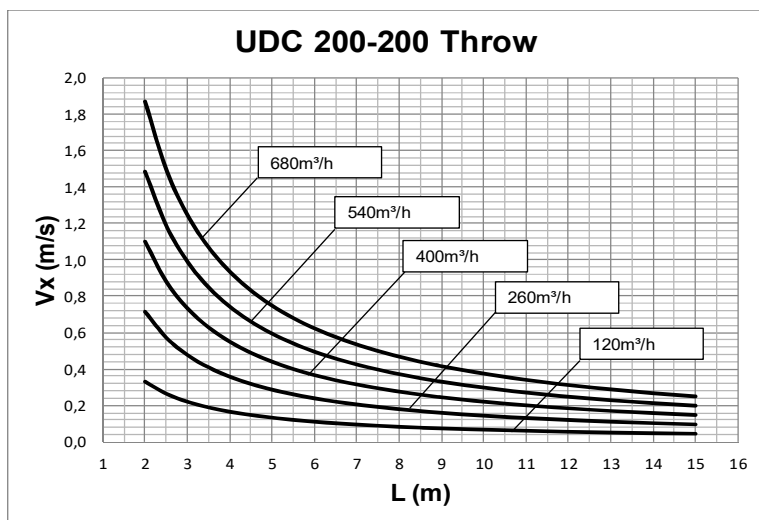

Values measured in isothermic conditions with horizontal blades in accordance with the following international standard:

ISO 5219 1984: *Air distribution and air diffusion - Laboratory. Aerodynamic testing and rating of air terminal devices.*

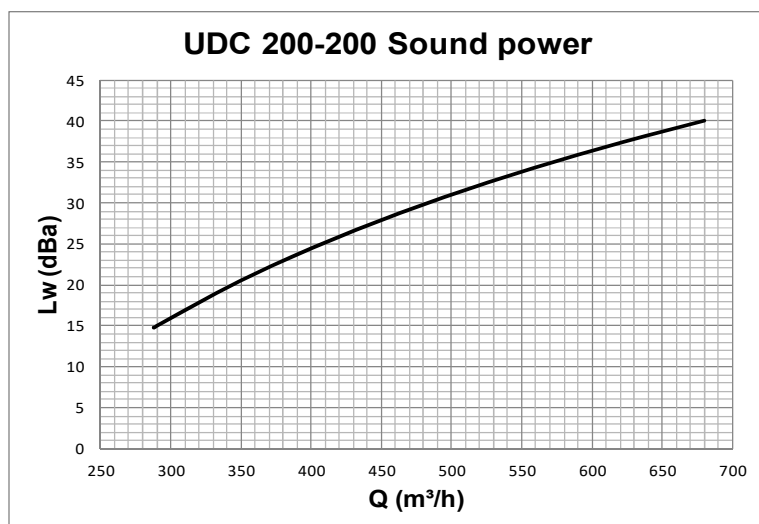
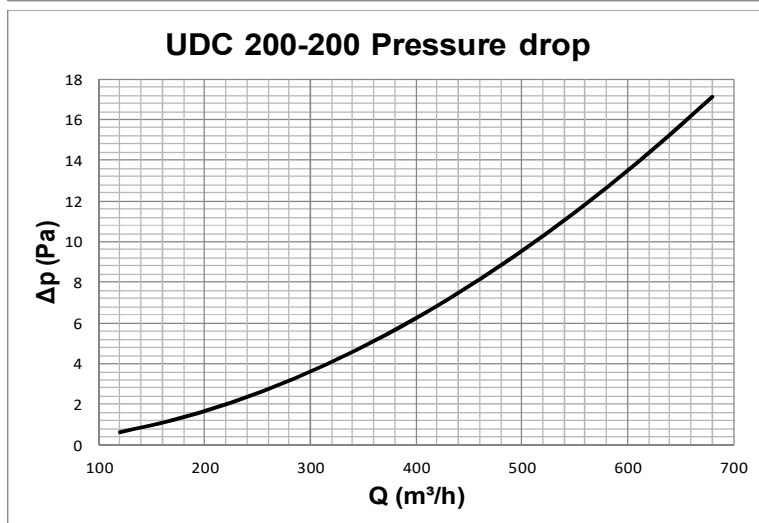

Data measured in reverberation room in accordance with international standards:
ISO 3741 1999: *Acoustic - determination of sound power levels of noise sources using sound pressure - Precision methods for reverberation rooms*
ISO 5135 1997: *Acoustic - determination of sound power levels of noise from air-terminal devices; air terminal units; dampers and valves by measurement in a reverberation room.*

The shown data does not take into consideration the attenuation resulting from the surroundings where the diffuser is installed. Such attenuation is normally included between 6 and 10 dBa and is determined by the size of the surrounding space, its shape and the characteristics of the furniture and room fittings.

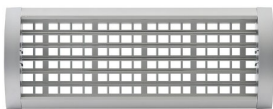

SUPPLY GRILLE FOR CIRCULAR DUCT

UDC
SERIES

UDC 200-300
PERFORMANCE

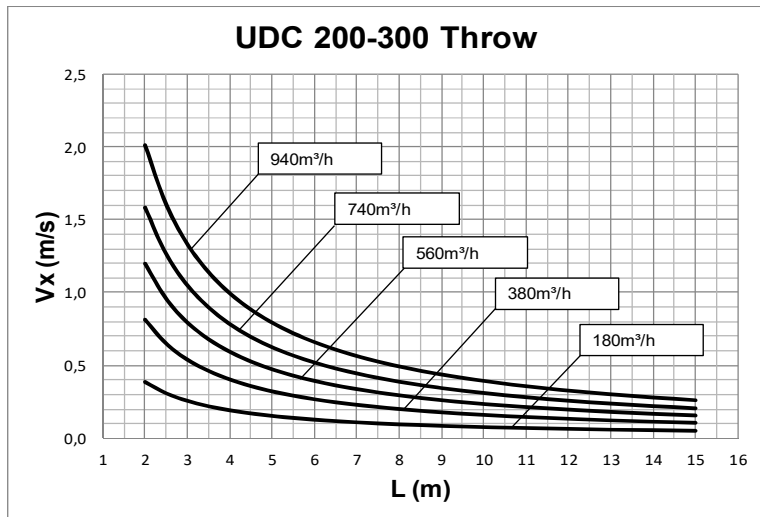

Values measured in isothermic conditions with horizontal blades in accordance with the following international standard:

ISO 5219 1984: *Air distribution and air diffusion - Laboratory. Aerodynamic testing and rating of air terminal devices.*

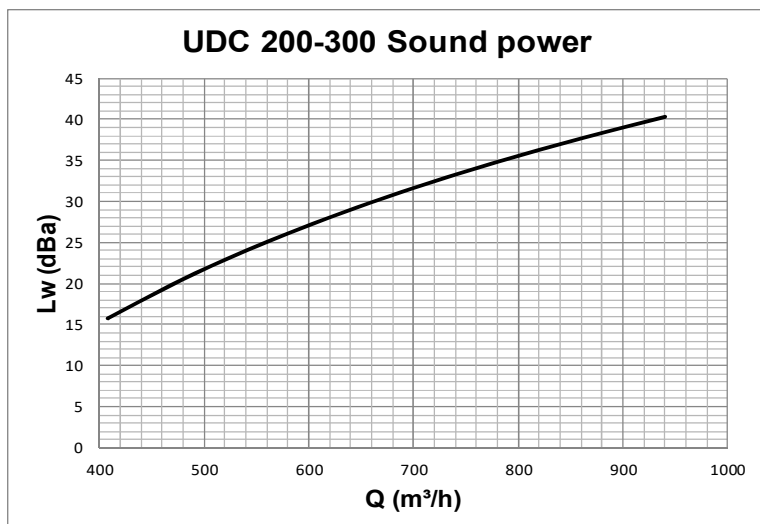
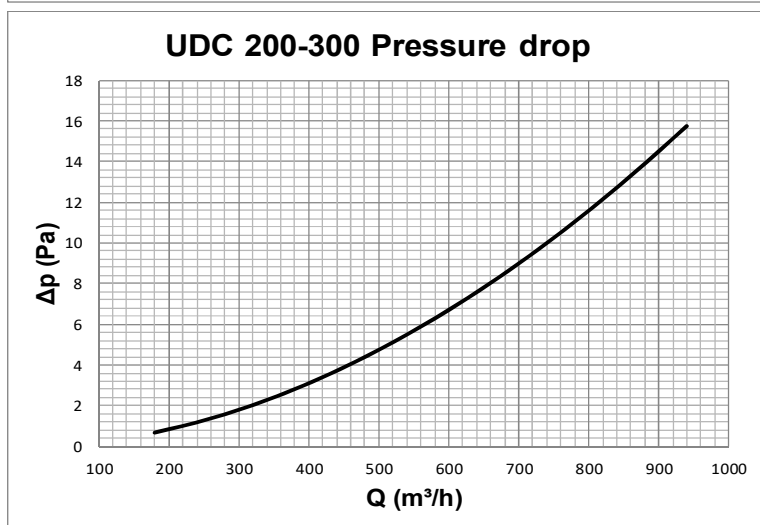

Data measured in reverberation room in accordance with international standards:
ISO 3741 1999: *Acoustic - determination of sound power levels of noise sources using sound pressure - Precision methods for reverberation rooms*
ISO 5135 1997: *Acoustic - determination of sound power levels of noise from air-terminal devices; air terminal units; dampers and valves by measurement in a reverberation room.*

The shown data does not take into consideration the attenuation resulting from the surroundings where the diffuser is installed. Such attenuation is normally included between 6 and 10 dBa and is determined by the size of the surrounding space, its shape and the characteristics of the furniture and room fittings.

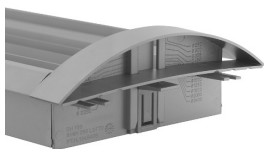

SUPPLY GRILLE FOR CIRCULAR DUCT

UDC SERIES

UDC 200-400 PERFORMANCE

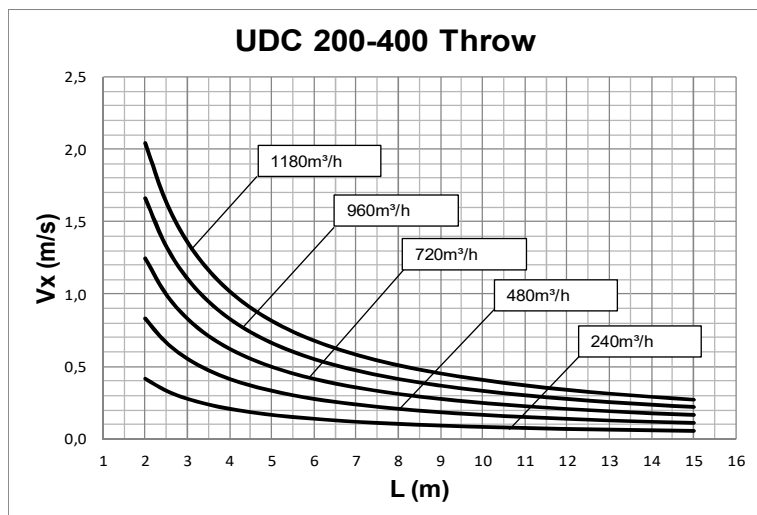

Values measured in isothermic conditions with horizontal blades in accordance with the following international standard:

ISO 5219 1984: *Air distribution and air diffusion - Laboratory. Aerodynamic testing and rating of air terminal devices.*

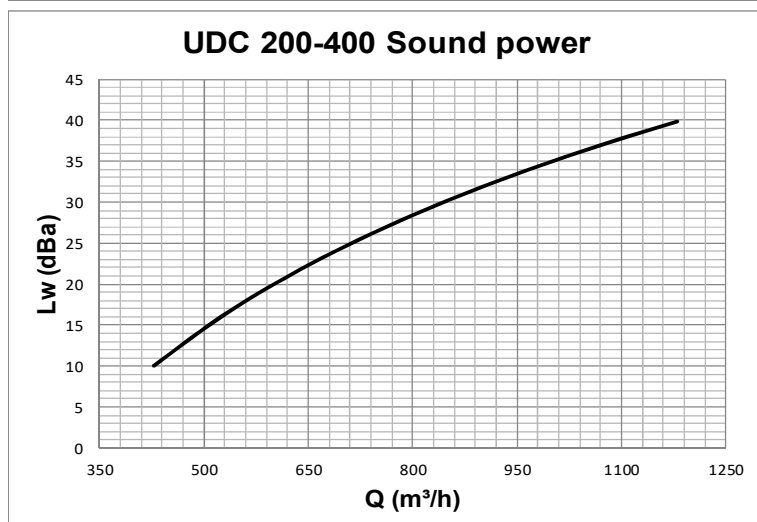
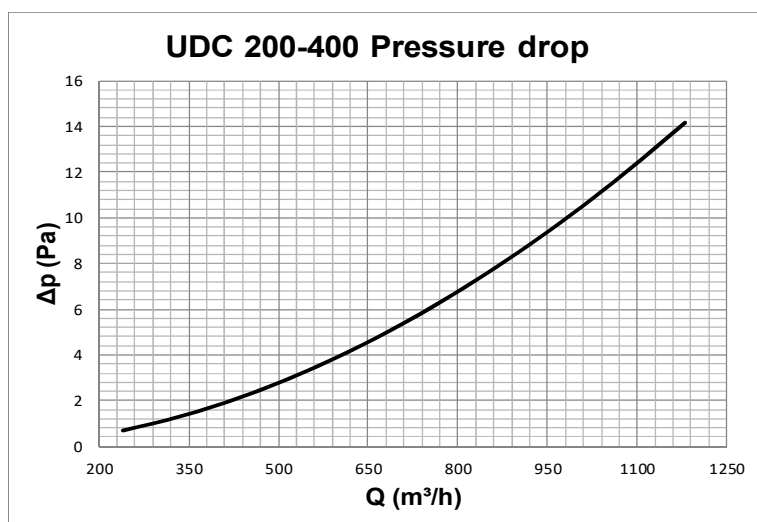

Data measured in reverberation room in accordance with international standards:
ISO 3741 1999: *Acoustic - determination of sound power levels of noise sources using sound pressure - Precision methods for reverberation rooms*
ISO 5135 1997: *Acoustic - determination of sound power levels of noise from air-terminal devices; air terminal units; dampers and valves by measurement in a reverberation room.*

The shown data does not take into consideration the attenuation resulting from the surroundings where the diffuser is installed. Such attenuation is normally included between 6 and 10 dBa and is determined by the size of the surrounding space, its shape and the characteristics of the furniture and room fittings.

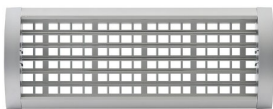

SUPPLY GRILLE FOR CIRCULAR DUCT

UDC
SERIES

UDC 200-500
PERFORMANCE

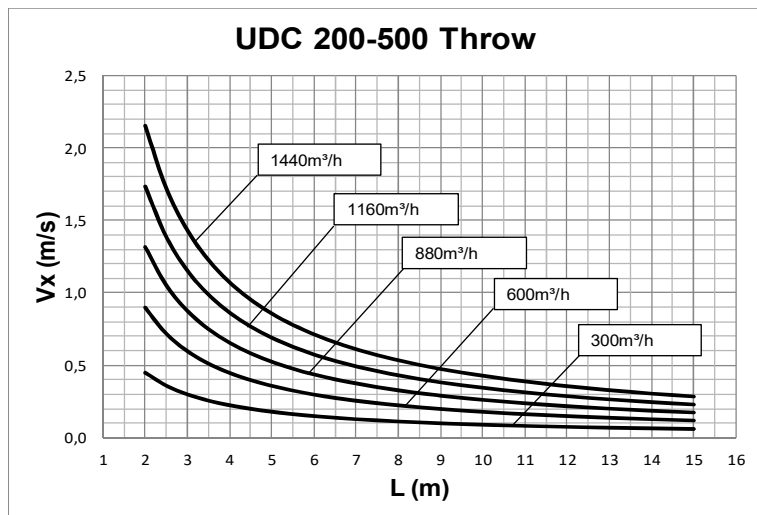

Values measured in isothermic conditions with horizontal blades in accordance with the following international standard:

ISO 5219 1984: *Air distribution and air diffusion - Laboratory. Aerodynamic testing and rating of air terminal devices.*

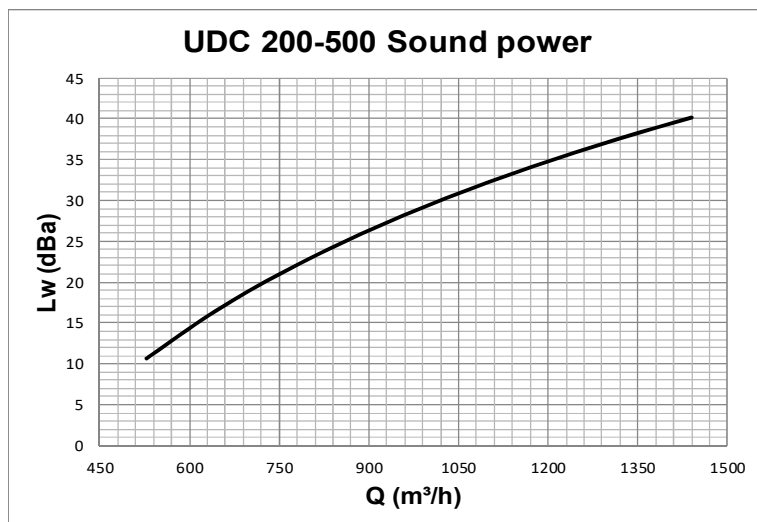
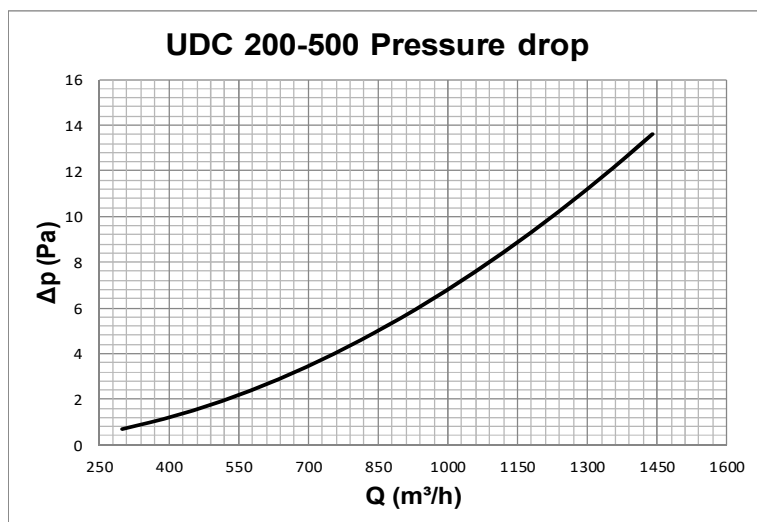

Data measured in reverberation room in accordance with international standards:
ISO 3741 1999: *Acoustic - determination of sound power levels of noise sources using sound pressure - Precision methods for reverberation rooms*
ISO 5135 1997: *Acoustic - determination of sound power levels of noise from air-terminal devices; air terminal units; dampers and valves by measurement in a reverberation room.*

The shown data does not take into consideration the attenuation resulting from the surroundings where the diffuser is installed. Such attenuation is normally included between 6 and 10 dBa and is determined by the size of the surrounding space, its shape and the characteristics of the furniture and room fittings.

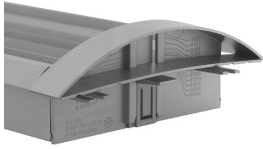

SUPPLY GRILLE FOR CIRCULAR DUCT

UDC
SERIES

UDC 200-600 PERFORMANCE

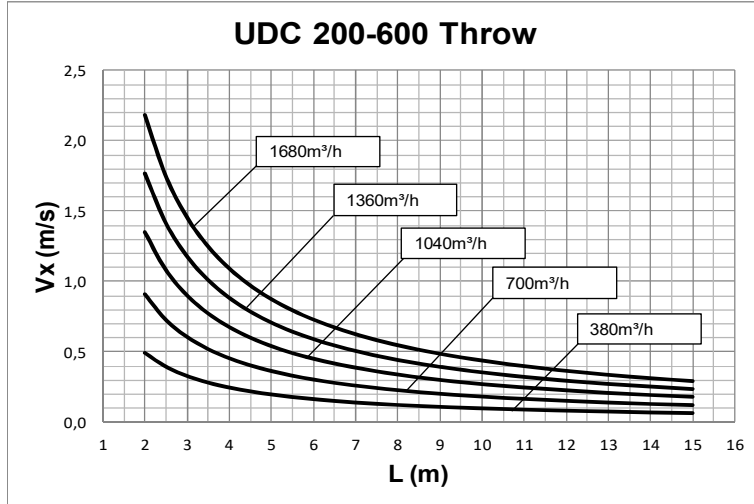

Values measured in isothermic conditions with horizontal blades in accordance with the following international standard:

ISO 5219 1984: *Air distribution and air diffusion - Laboratory. Aerodynamic testing and rating of air terminal devices.*

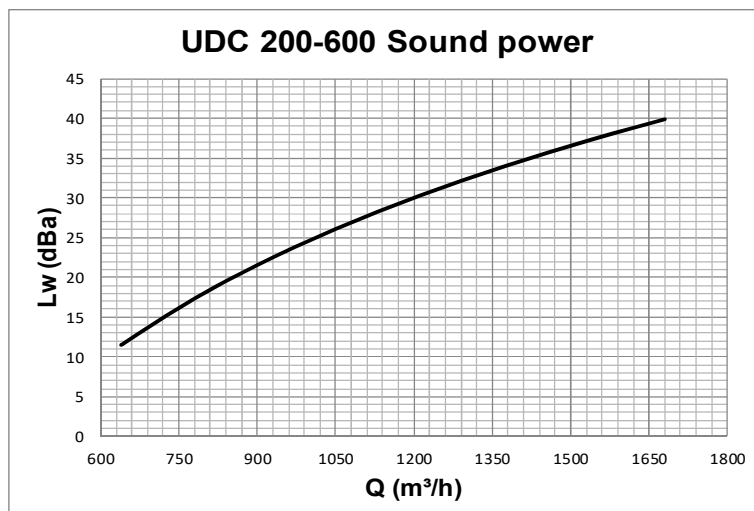
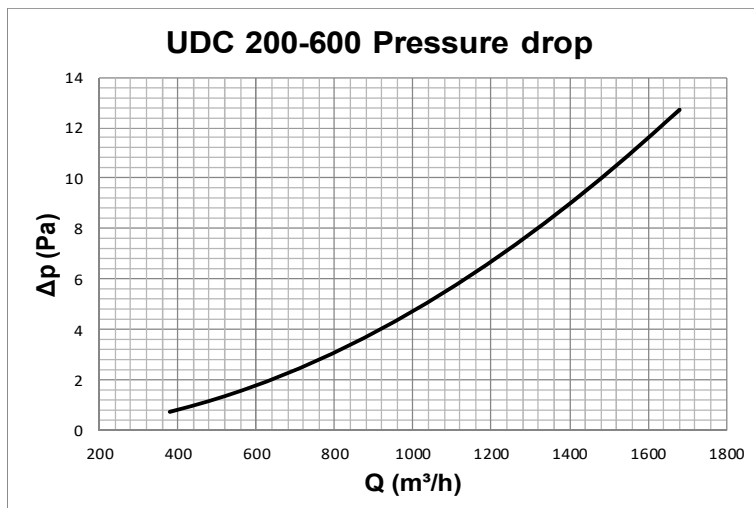

Data measured in reverberation room in accordance with international standards:
ISO 3741 1999: *Acoustic - determination of sound power levels of noise sources using sound pressure - Precision methods for reverberation rooms*

ISO 5135 1997: *Acoustic - determination of sound power levels of noise from air-terminal devices; air terminal units; dampers and valves by measurement in a reverberation room.*

The shown data does not take into consideration the attenuation resulting from the surroundings where the diffuser is installed. Such attenuation is normally included between 6 and 10 dBa and is determined by the size of the surrounding space, its shape and the characteristics of the furniture and room fittings.

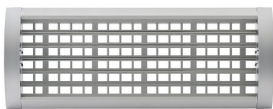

SUPPLY GRILLE FOR CIRCULAR DUCT

UDC
SERIES

UDC 200-800
PERFORMANCE

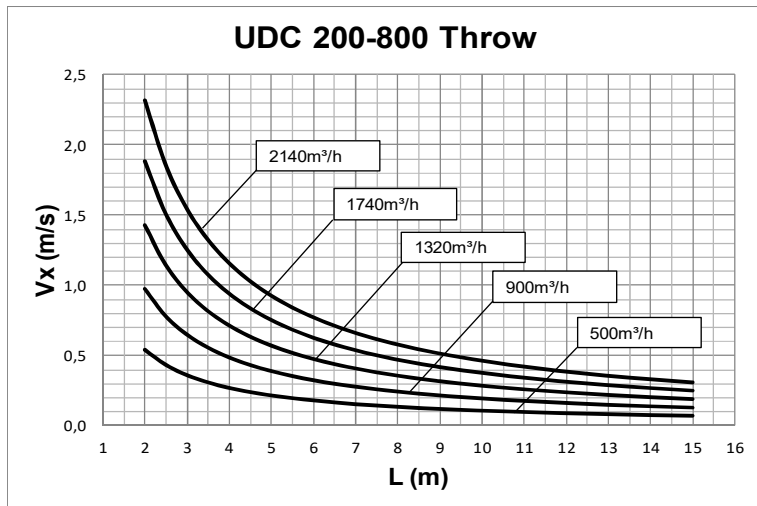

Values measured in isothermic conditions with horizontal blades in accordance with the following international standard:

ISO 5219 1984: *Air distribution and air diffusion - Laboratory. Aerodynamic testing and rating of air terminal devices.*

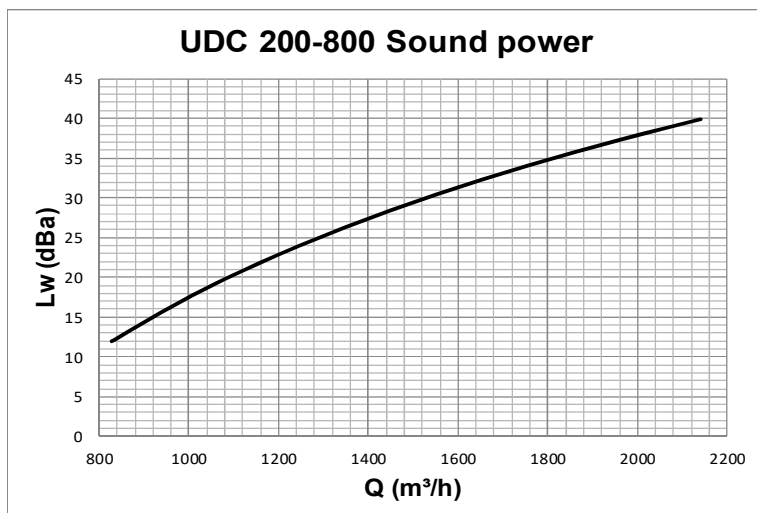
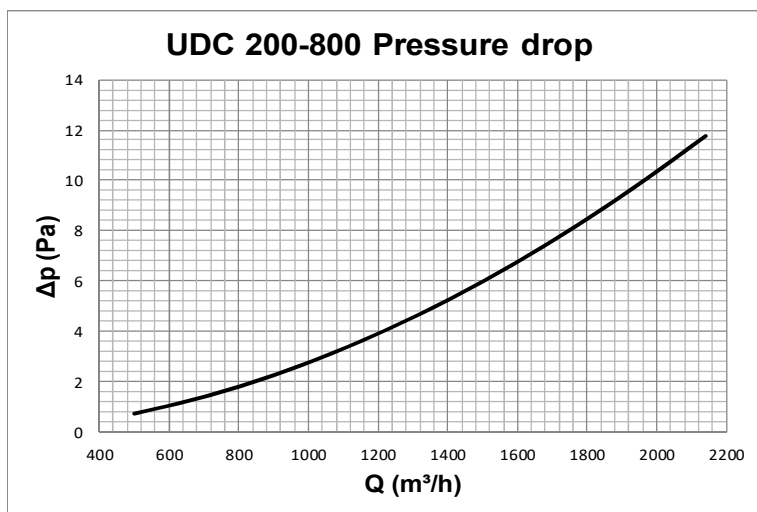

Data measured in reverberation room in accordance with international standards:
ISO 3741 1999: *Acoustic - determination of sound power levels of noise sources using sound pressure - Precision methods for reverberation rooms*
ISO 5135 1997: *Acoustic - determination of sound power levels of noise from air-terminal devices; air terminal units; dampers and valves by measurement in a reverberation room.*

The shown data does not take into consideration the attenuation resulting from the surroundings where the diffuser is installed. Such attenuation is normally included between 6 and 10 dBa and is determined by the size of the surrounding space, its shape and the characteristics of the furniture and room fittings.

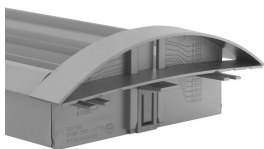

SUPPLY GRILLE FOR CIRCULAR DUCT

UDC
SERIES

UDC 200-1000
PERFORMANCE

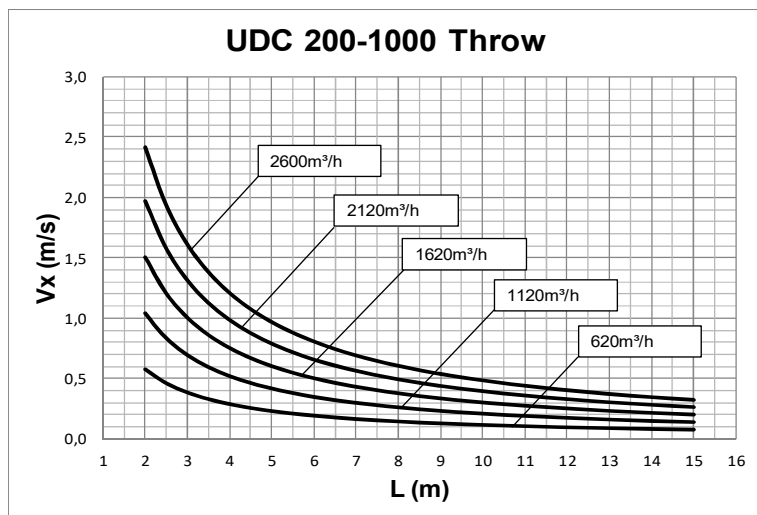

Values measured in isothermic conditions with horizontal blades in accordance with the following international standard:

ISO 5219 1984: *Air distribution and air diffusion - Laboratory. Aerodynamic testing and rating of air terminal devices.*

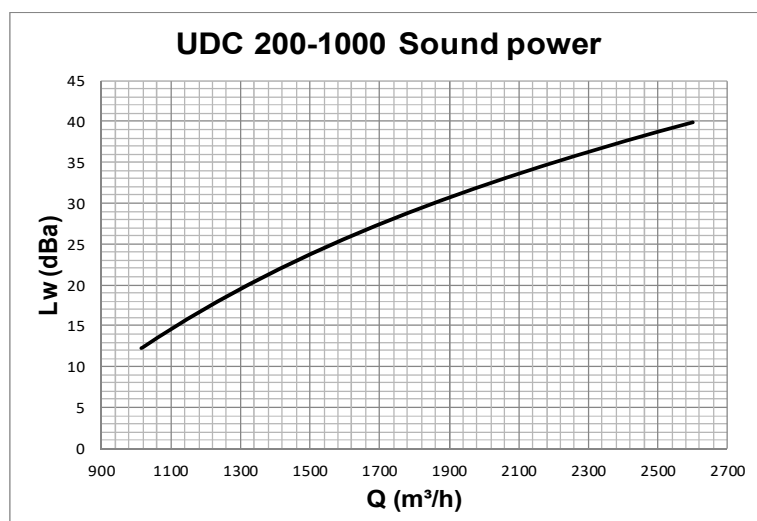
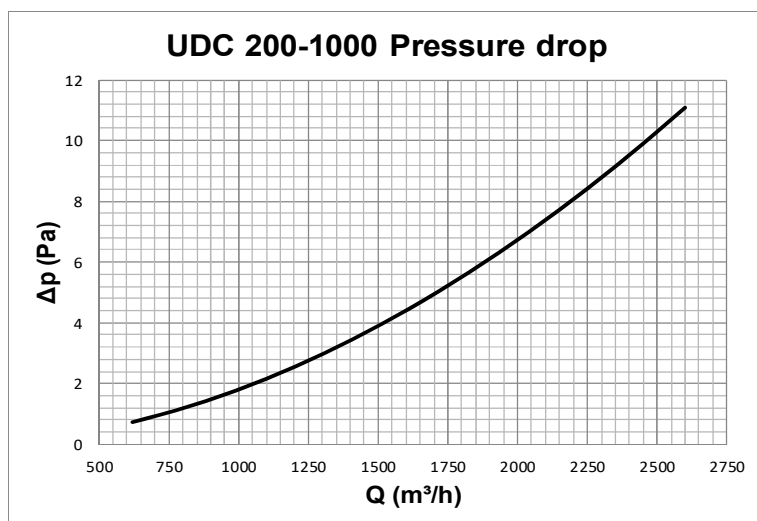

Data measured in reverberation room in accordance with international standards:
ISO 3741 1999: *Acoustic - determination of sound power levels of noise sources using sound pressure - Precision methods for reverberation rooms*
ISO 5135 1997: *Acoustic - determination of sound power levels of noise from air-terminal devices; air terminal units; dampers and valves by measurement in a reverberation room.*

The shown data does not take into consideration the attenuation resulting from the surroundings where the diffuser is installed. Such attenuation is normally included between 6 and 10 dBa and is determined by the size of the surrounding space, its shape and the characteristics of the furniture and room fittings.



SUPPLY GRILLE FOR CIRCULAR DUCT

UDC
SERIES

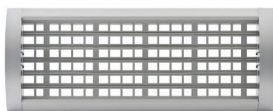

AVAILABLE SIZES
HOW TO ORDER

As a result of the adjustable ends, the UDC circular duct grilles can be fitted without being modified or adapted to a wide range of diameters, as shown below.

| L X H | | D |
|-------|-----|-----------------------|
| mm | | |
| 200 | 100 | 160 ↑ ↓ 2400 |
| 300 | 100 | |
| 400 | 100 | |
| 500 | 100 | |
| 600 | 100 | |
| 800 | 100 | |
| 1000 | 100 | 2400 |

The 100mm high grille can be used on circular ducts with diameters ranging from 160 to 2400mm. The length of the grille does not influence the choice in this respect.

| L X H | | D |
|-------|-----|-----------------------|
| mm | | |
| 200 | 150 | 250 ↑ ↓ 2400 |
| 300 | 150 | |
| 400 | 150 | |
| 500 | 150 | |
| 600 | 150 | |
| 800 | 150 | |
| 1000 | 150 | 2400 |

The 150mm high grille can be used on circular ducts with diameters ranging from 250 to 2400mm. The length of the grille does not influence the choice in this respect.

| L X H | | D |
|-------|-----|-----------------------|
| mm | | |
| 200 | 200 | 315 ↑ ↓ 2400 |
| 300 | 200 | |
| 400 | 200 | |
| 500 | 200 | |
| 600 | 200 | |
| 800 | 200 | |
| 1000 | 200 | 2400 |

The 200mm high grille can be used on circular ducts with diameters ranging from 315 to 2400mm. The length of the grille does not influence the choice in this respect.

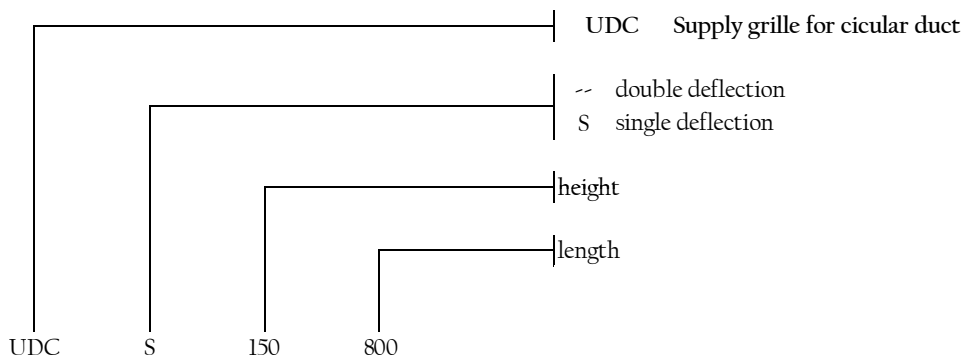
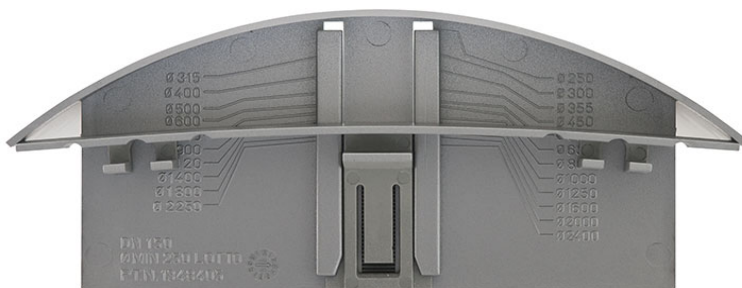



SUPPLY GRILLE FOR CIRCULAR DUCT

UDC
SERIES

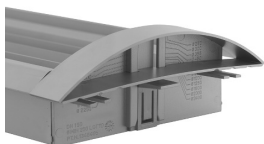

INSTALLATION

The UDC circular duct grilles are an innovative product with a high aesthetic quality. All models have a gasket which guarantees contact with the air duct in complete on all the diameter. It is installed following three simple steps, as shown here below :

1) GRILLE HOUSING IN THE DUCT

Proceed with cutting the hole in the duct.
The dimensions of the hole are equal to the nominal dimensions of the grille, as indicated in our catalogues and brochures.

Example: Grille 500x150 = Hole 500x150

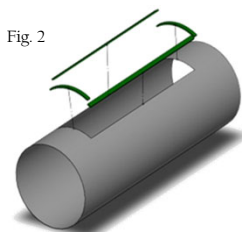
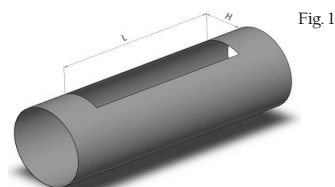

2) GASKET CUTTING AND POSITIONING

Once the hole has been made, proceed with preparing and installing the air tight gasket on the edge of the hole mad already made.

Cut four pieces of the gasket to size, two for length L and two for length H + 10mm.

Individually fix each piece so as to make a perfect continuous frame, as shown in Fig. 2 to ensure a better air tight seal.

3) DUCT DIAMETER REGULATION

Before inserting the grille in its housing, it is necessary to adjust the ends to fit duct's diameter (Fig. 3).

The end piece is equipped with a graduated scale showing the various positions for the possible dimensions. Chose the position as necessary.

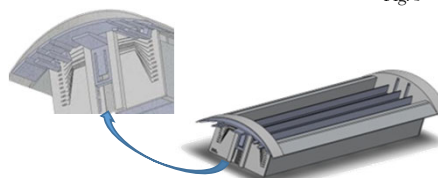

4) POSITIONING THE GRILLE IN THE HOUSING

Fig. 4



Once the end pieces have been adjusted as necessary, the grille can now be placed in its housing (Fig. 4).

Hold the grill at 30°, taking care to insert first the end with the longer blades (as per Fig. 7) making sure to correctly align the end piece with the duct and the gasket (as per Fig. 5).

Fig. 5

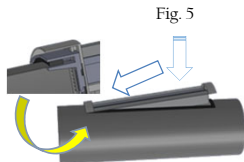

Proceed carefully by resting the other part of the grille on the duct, apply a gentle force to press the gasket and in a lateral movement proceed with fixing the grille in place (Fig. 6).

During this process it is necessary to be sure that the gasket remains correctly in place between the duct and the grille.

Fig. 6

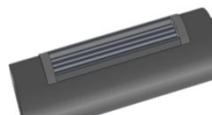
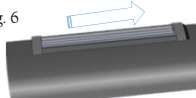

insert first the end with the longer blades

Fig. 7

