



RECTANGULAR HIGH INDUCTION DIFFUSERS

KQ-43
SERIES

OVERVIEW

OVERVIEW :

These are high induction diffusers built similarly to the KQ42 models but rectangular in shape. Made in carbon steel with a an epoxy powder finish in RAL 9010, with deflectors in polycarbonate+ white ABS RAL

Model	A mm	B mm	n° of nozzels	Ak m ²	
KQ43-1150425	150	450	14	0,0036	
KQ43-1150525	150	550	18	0,0047	
KQ43-1150625	150	650	22	0,0057	
KQ43-1150825	150	850	30	0,0078	
KQ43-1151025	150	1050	38	0,0098	
KQ43-2150425	250	450	21	0,0055	
KQ43-2150525	250	550	27	0,0070	
KQ43-2150625	250	650	33	0,0086	
KQ43-2150825	250	850	45	0,0116	
KQ43-2151025	250	1050	57	0,0147	
KQ43-3150425	350	450	35	0,0091	
KQ43-3150525	350	550	45	0,0116	
KQ43-3150625	350	650	55	0,0142	
KQ43-3150825	350	850	75	0,0194	
KQ43-3151025	350	1050	95	0,0245	

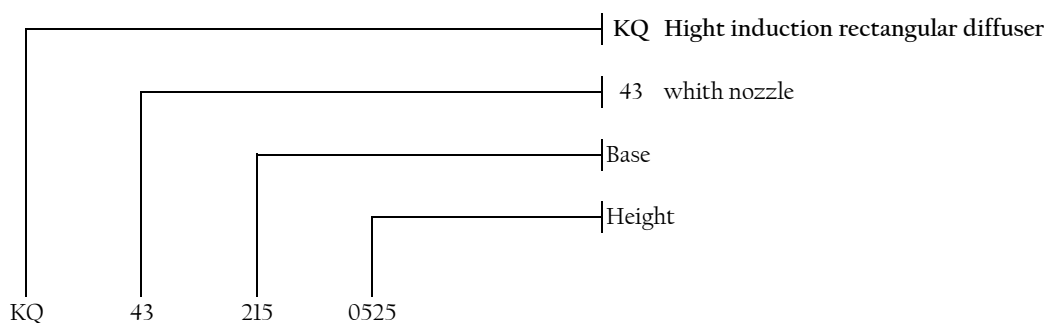



RECTANGULAR HIGH INDUCTION DIFFUSERS

KQ-43
SERIES

PERFORMANCE
KQ43 1150425

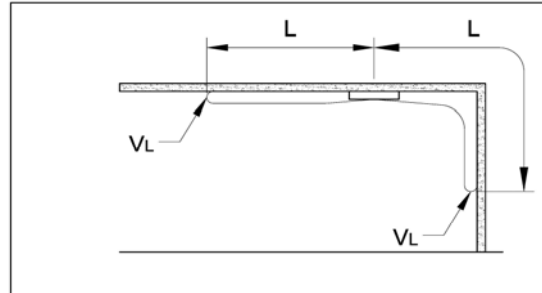
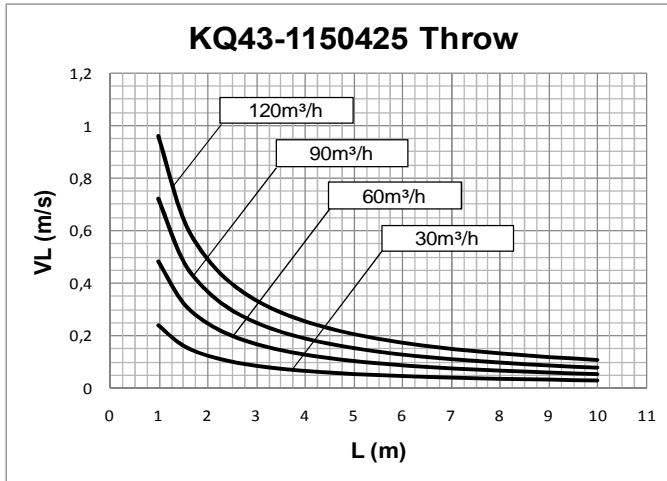

Data measured in isothermic conditions in accordance with international standards:
ISO 5219 1984: *Air distribution and air diffusion - Laboratory. Aerodynamic testing and rating of air terminal devices.*

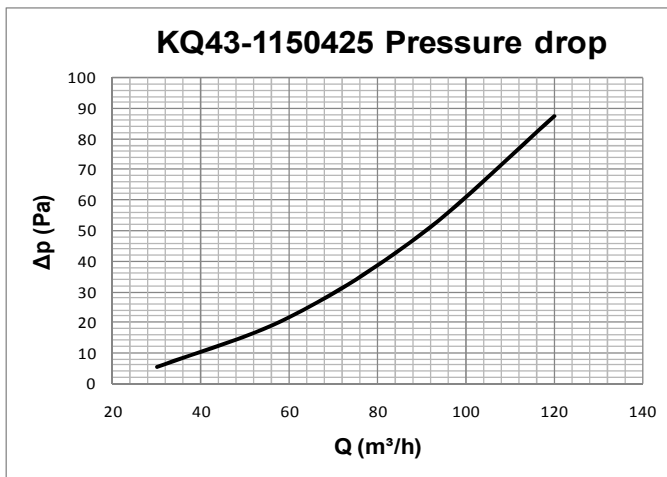

L (m) horizontal distance in metres from the centre of the diffuser

V_L (m/s) maximum speed in the air stream

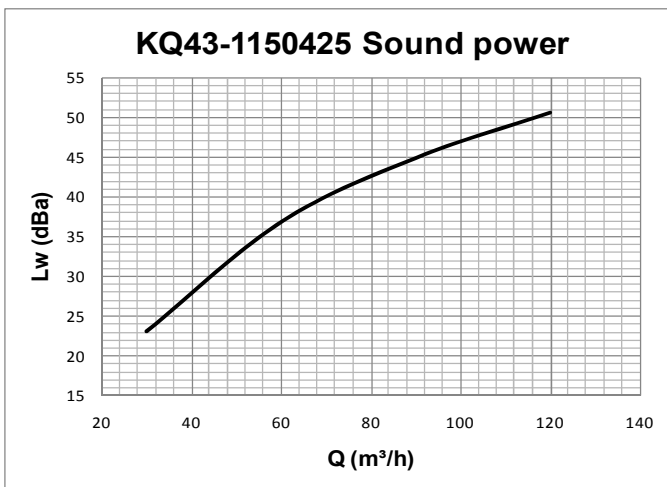

Data measured in reverberation room in accordance with international standards:

ISO 3741 1999: *Acoustic - determination of sound power levels of noise sources using sound pressure - Precision methods for reverberation rooms*

ISO 5135 1997: *Acoustic - determination of sound power levels of noise from air-terminal devices; air terminal units; dampers and valves by measurement in a reverberation room.*

The data presented does not consider the attenuation given by the area of installation. This attenuation is normally between 6 and 10 dBA and is determined by the room size, the shape of the environment and the interior features.



RECTANGULAR HIGH INDUCTION DIFFUSERS

KQ-43
SERIES

PERFORMANCE
KQ43 1150525

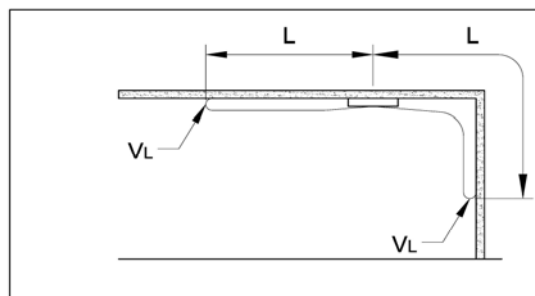
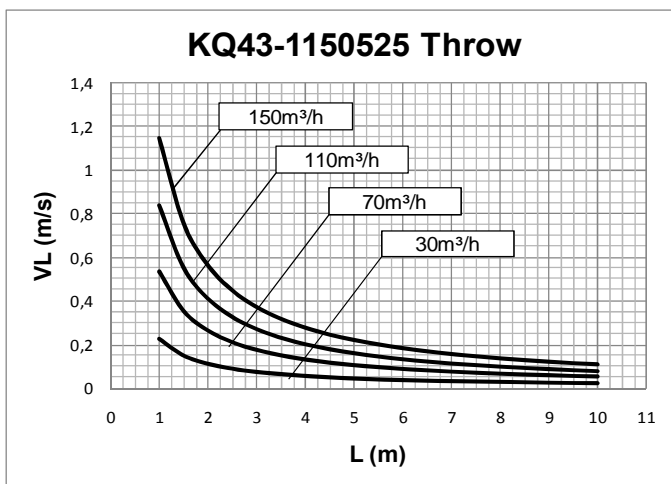

Data measured in isothermic conditions in accordance with international standards:
ISO 5219 1984: *Air distribution and air diffusion - Laboratory. Aerodynamic testing and rating of air terminal devices.*

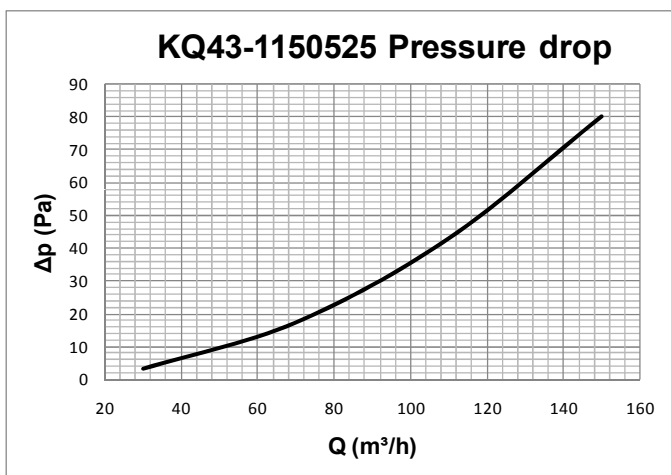

L (m) horizontal distance in metres from the centre of the diffuser
VL (m/s) maximum speed in the air stream

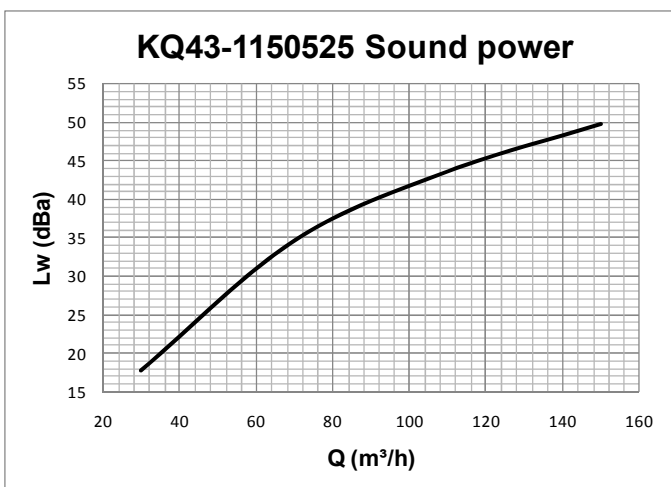

Data measured in reverberation room in accordance with international standards:
ISO 3741 1999: *Acoustic - determination of sound power levels of noise sources using sound pressure - Precision methods for reverberation rooms*

ISO 5135 1997: *Acoustic - determination of sound power levels of noise from air-terminal devices; air terminal units; dampers and valves by measurement in a reverberation room.*

The data presented does not consider the attenuation given by the area of installation. This attenuation is normally between 6 and 10 dBA and is determined by the room size, the shape of the environment and the interior features.



RECTANGULAR HIGH INDUCTION DIFFUSERS

KQ-43
SERIES

PERFORMANCE
KQ43 1150625

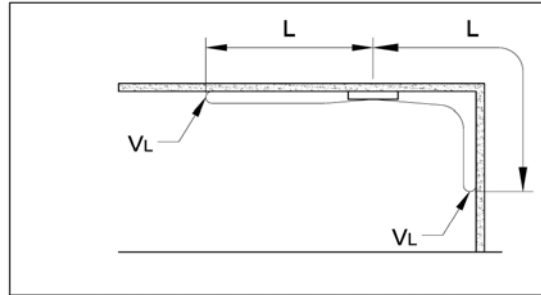
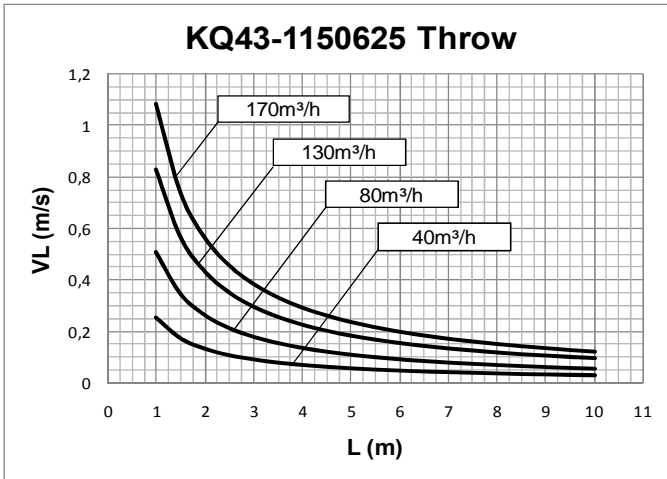

Data measured in isothermic conditions in accordance with international standards:
ISO 5219 1984: Air distribution and air diffusion - Laboratory. Aerodynamic testing and rating of air terminal devices.

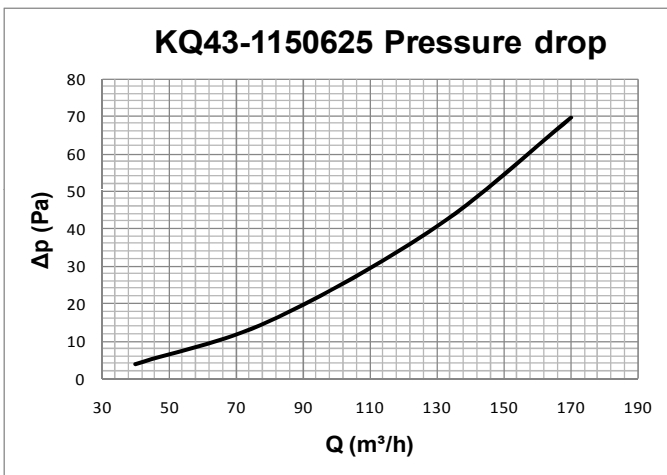

L (m) horizontal distance in metres from the centre of the diffuser
VL (m/s) maximum speed in the air stream

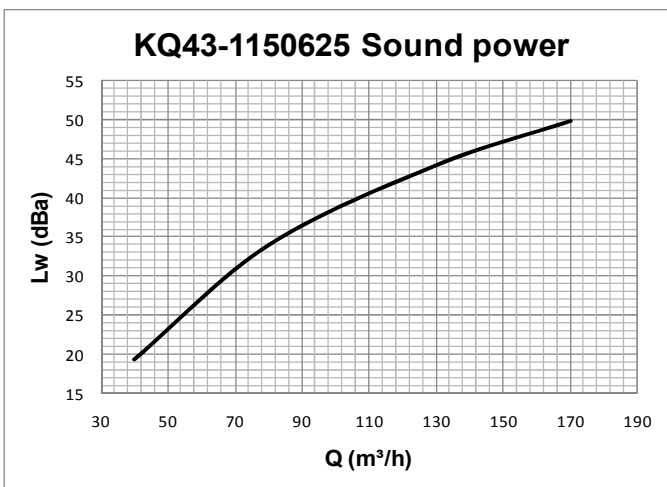

Data measured in reverberation room in accordance with international standards:
ISO 3741 1999: Acoustic - determination of sound power levels of noise sources using sound pressure - Precision methods for reverberation rooms

ISO 5135 1997: Acoustic - determination of sound power levels of noise from air-terminal devices; air terminal units; dampers and valves by measurement in a reverberation room.

The data presented does not consider the attenuation given by the area of installation. This attenuation is normally between 6 and 10 dBA and is determined by the room size, the shape of the environment and the interior features.



RECTANGULAR HIGH INDUCTION DIFFUSERS

KQ-43
SERIES

PERFORMANCE
KQ43 1150825

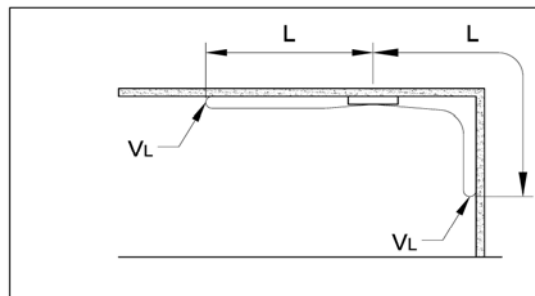
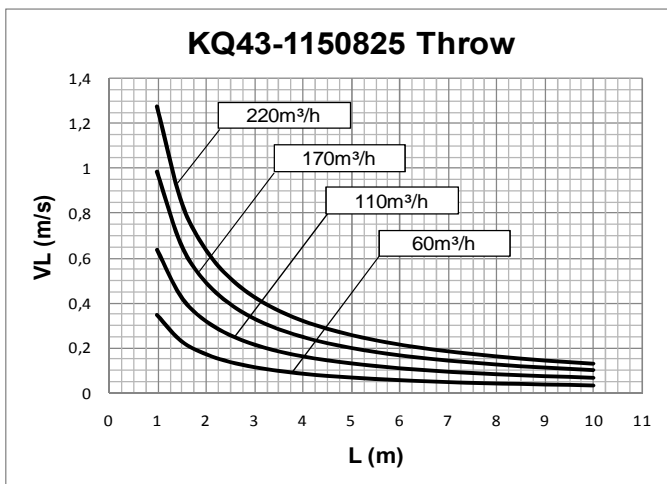

Data measured in isothermic conditions in accordance with international standards:
ISO 5219 1984: *Air distribution and air diffusion - Laboratory. Aerodynamic testing and rating of air terminal devices.*

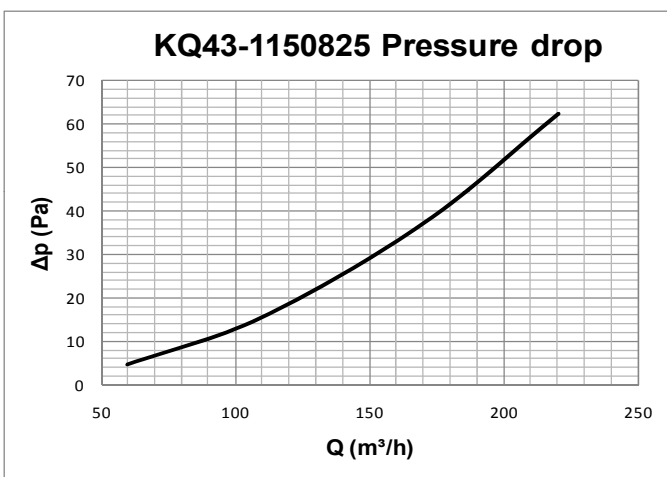

L (m) horizontal distance in metres from the centre of the diffuser
VL (m/s) maximum speed in the air stream

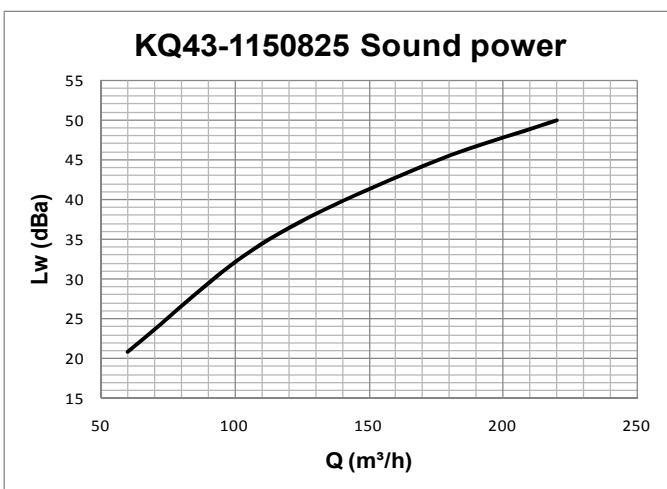

Data measured in reverberation room in accordance with international standards:
ISO 3741 1999: *Acoustic - determination of sound power levels of noise sources using sound pressure - Precision methods for reverberation rooms*

ISO 5135 1997: *Acoustic - determination of sound power levels of noise from air-terminal devices; air terminal units; dampers and valves by measurement in a reverberation room.*

The data presented does not consider the attenuation given by the area of installation. This attenuation is normally between 6 and 10 dBA and is determined by the room size, the shape of the environment and the interior features.



RECTANGULAR HIGH INDUCTION DIFFUSERS

KQ-43
SERIES

PERFORMANCE
KQ43 1151025

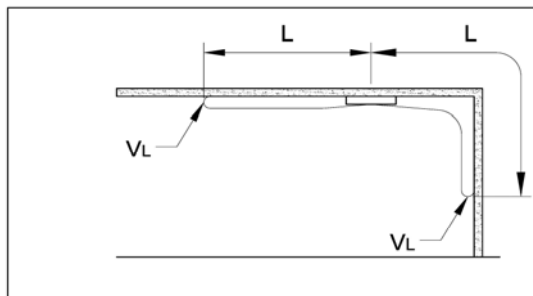
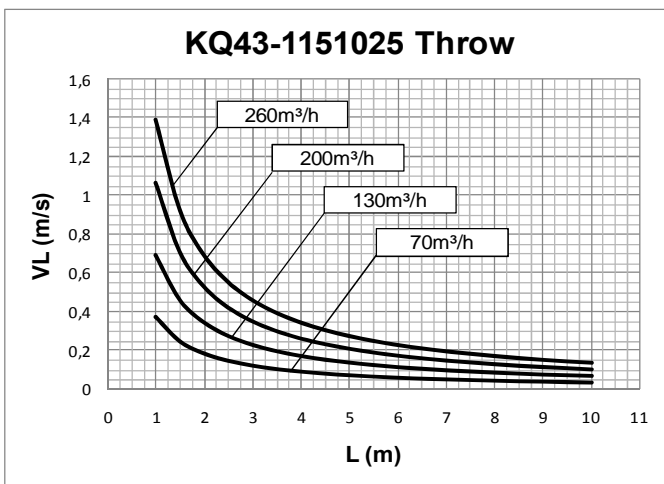

Data measured in isothermic conditions in accordance with international standards:
ISO 5219 1984: *Air distribution and air diffusion - Laboratory. Aerodynamic testing and rating of air terminal devices.*

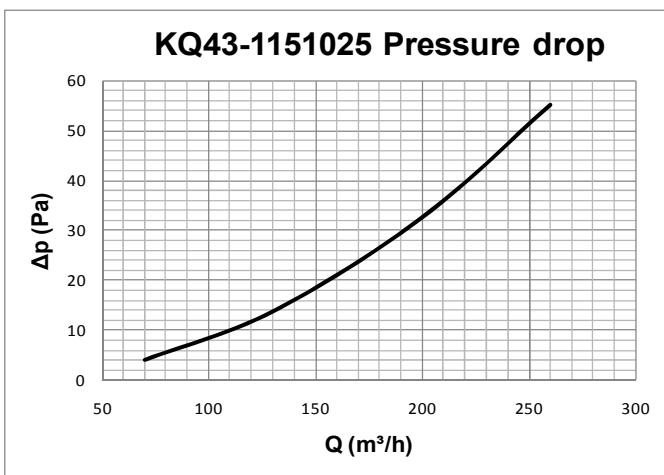

L (m) horizontal distance in metres from the centre of the diffuser
VL (m/s) maximum speed in the air stream

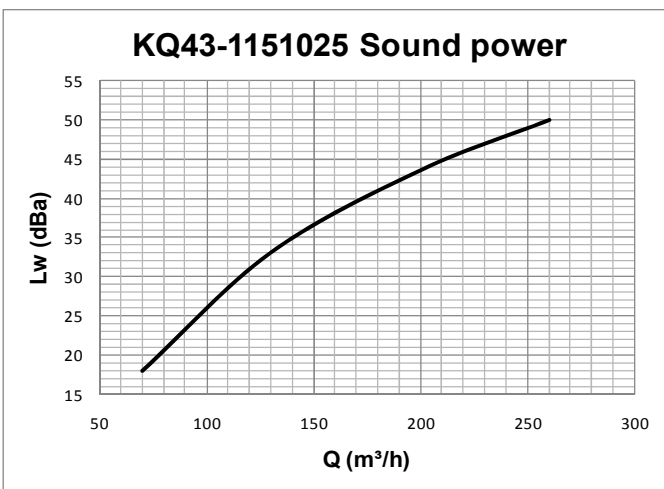

Data measured in reverberation room in accordance with international standards:
ISO 3741 1999: *Acoustic - determination of sound power levels of noise sources using sound pressure - Precision methods for reverberation rooms*

ISO 5135 1997: *Acoustic - determination of sound power levels of noise from air-terminal devices; air terminal units; dampers and valves by measurement in a reverberation room.*

The data presented does not consider the attenuation given by the area of installation. This attenuation is normally between 6 and 10 dBA and is determined by the room size, the shape of the environment and the interior features.



RECTANGULAR HIGH INDUCTION DIFFUSERS

KQ-43
SERIES

PERFORMANCE
KQ43 2150425

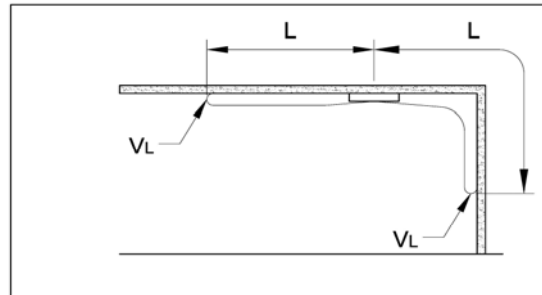
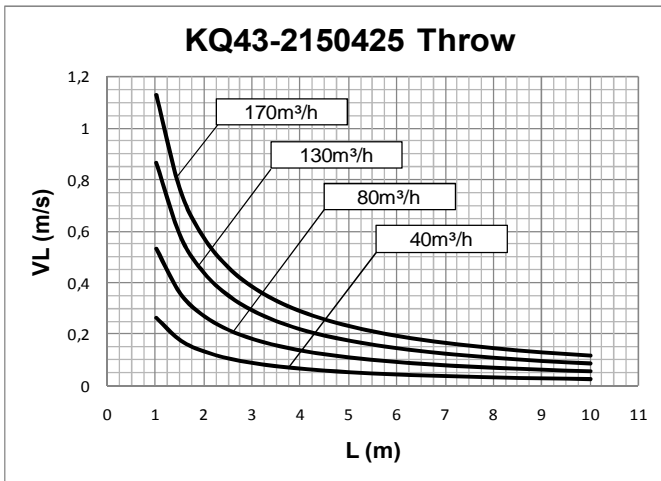

Data measured in isothermic conditions in accordance with international standards:
ISO 5219 1984: *Air distribution and air diffusion - Laboratory. Aerodynamic testing and rating of air terminal devices.*

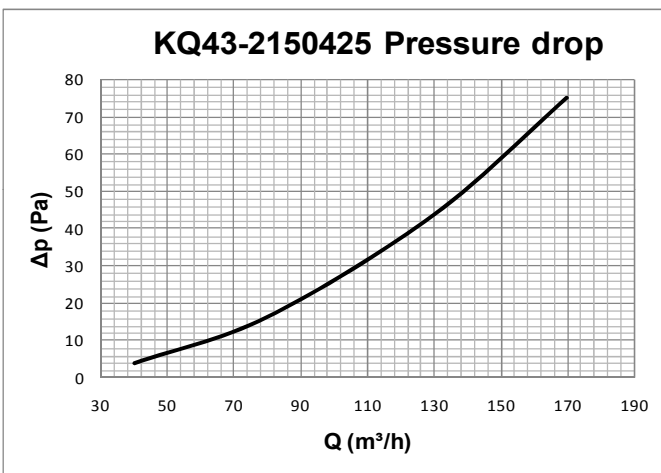

L (m) horizontal distance in metres from the centre of the diffuser
VL (m/s) maximum speed in the air stream

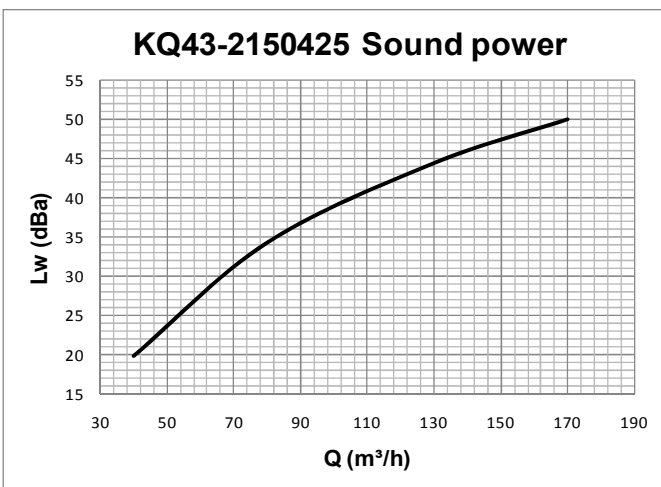

Data measured in reverberation room in accordance with international standards:
ISO 3741 1999: *Acoustic - determination of sound power levels of noise sources using sound pressure - Precision methods for reverberation rooms*

ISO 5135 1997: *Acoustic - determination of sound power levels of noise from air-terminal devices; air terminal units; dampers and valves by measurement in a reverberation room.*

The data presented does not consider the attenuation given by the area of installation. This attenuation is normally between 6 and 10 dBA and is determined by the room size, the shape of the environment and the interior features.



RECTANGULAR HIGH INDUCTION DIFFUSERS

KQ-43
SERIES

PERFORMANCE
KQ43 2150525

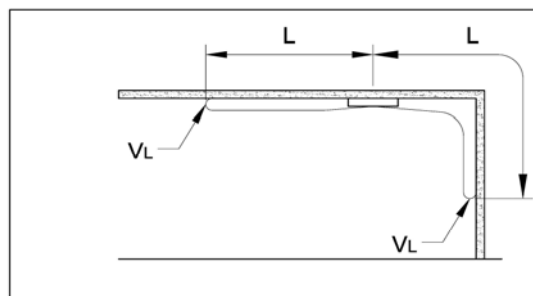
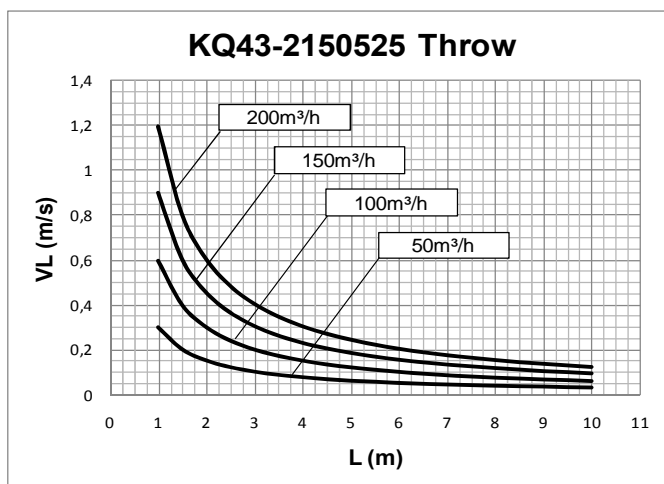

Data measured in isothermic conditions in accordance with international standards:
ISO 5219 1984: Air distribution and air diffusion - Laboratory. Aerodynamic testing and rating of air terminal devices.

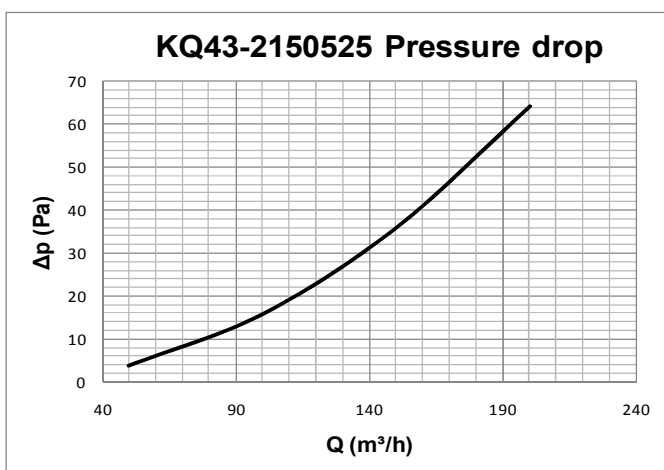

L (m) horizontal distance in metres from the centre of the diffuser
 V_L (m/s) maximum speed in the air stream

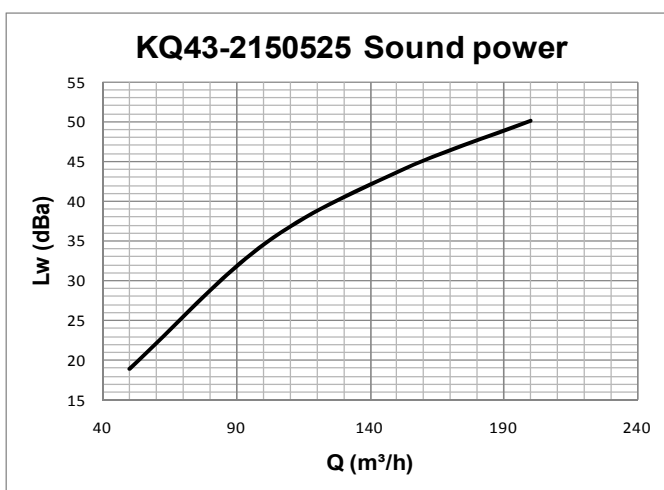

Data measured in reverberation room in accordance with international standards:
ISO 3741 1999: Acoustic - determination of sound power levels of noise sources using sound pressure - Precision methods for reverberation rooms

ISO 5135 1997: Acoustic - determination of sound power levels of noise from air-terminal devices; air terminal units; dampers and valves by measurement in a reverberation room.

The data presented does not consider the attenuation given by the area of installation. This attenuation is normally between 6 and 10 dBA and is determined by the room size, the shape of the environment and the interior features.



RECTANGULAR HIGH INDUCTION DIFFUSERS

KQ-43
SERIES

PERFORMANCE
KQ43 2150625

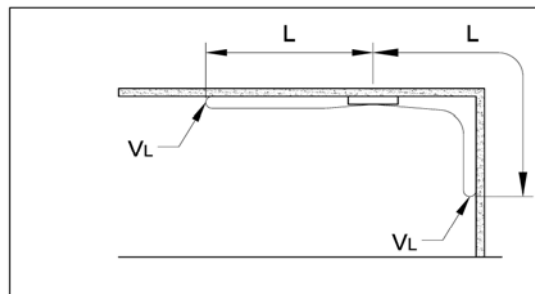
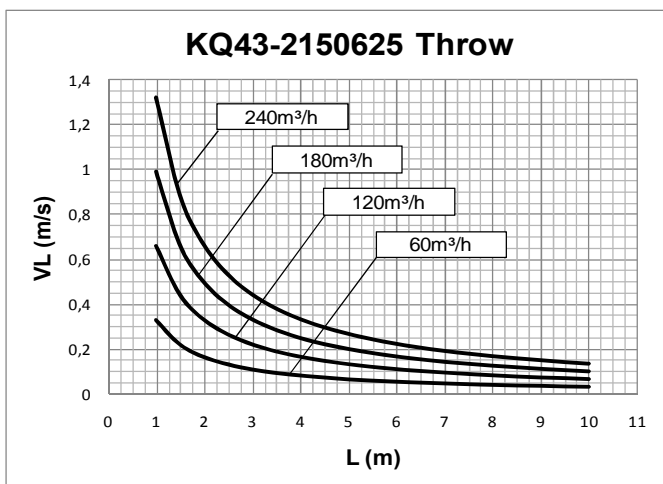

Data measured in isothermic conditions in accordance with international standards:
ISO 5219 1984: *Air distribution and air diffusion - Laboratory. Aerodynamic testing and rating of air terminal devices.*

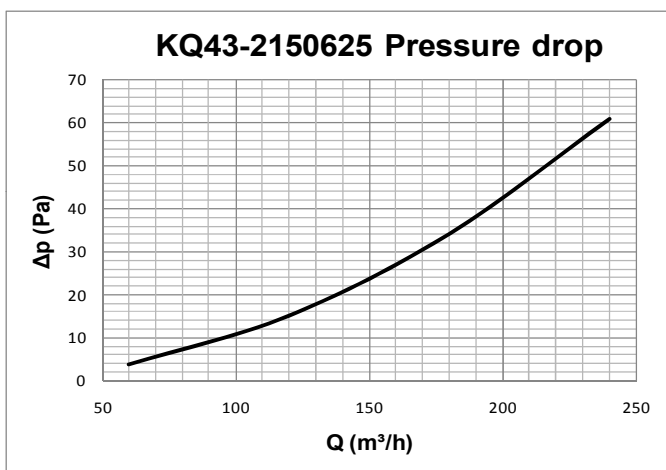

L (m) horizontal distance in metres from the centre of the diffuser
VL (m/s) maximum speed in the air stream

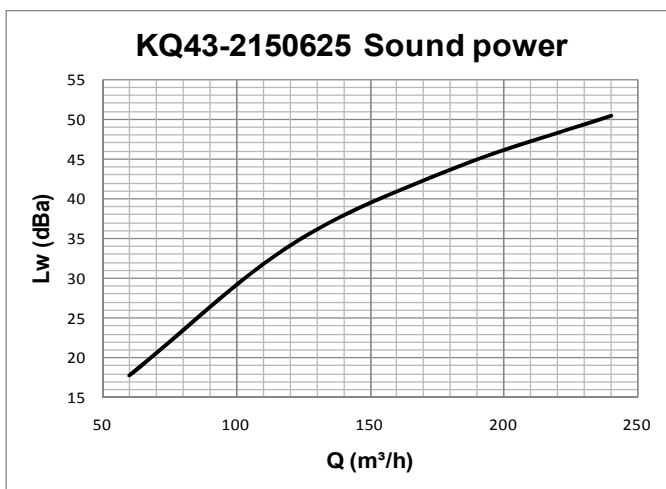

Data measured in reverberation room in accordance with international standards:
ISO 3741 1999: *Acoustic - determination of sound power levels of noise sources using sound pressure - Precision methods for reverberation rooms*

ISO 5135 1997: *Acoustic - determination of sound power levels of noise from air-terminal devices; air terminal units; dampers and valves by measurement in a reverberation room.*

The data presented does not consider the attenuation given by the area of installation. This attenuation is normally between 6 and 10 dBA and is determined by the room size, the shape of the environment and the interior features.



RECTANGULAR HIGH INDUCTION DIFFUSERS

KQ-43
SERIES

PERFORMANCE
KQ43 2150825

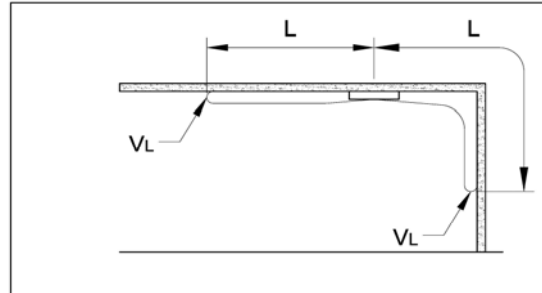
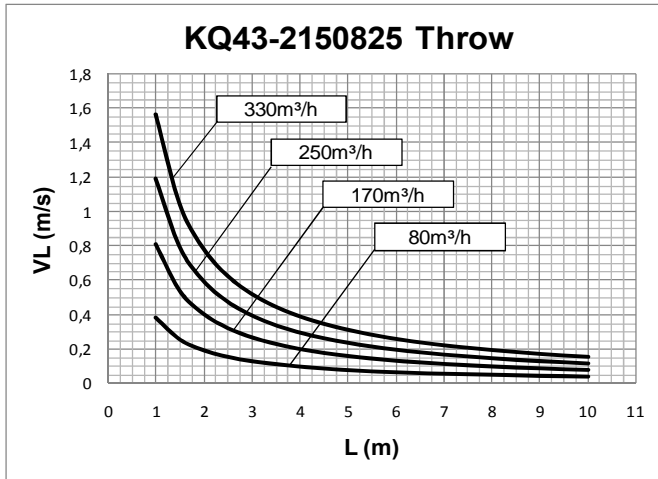

Data measured in isothermic conditions in accordance with international standards:
ISO 5219 1984: *Air distribution and air diffusion - Laboratory. Aerodynamic testing and rating of air terminal devices.*

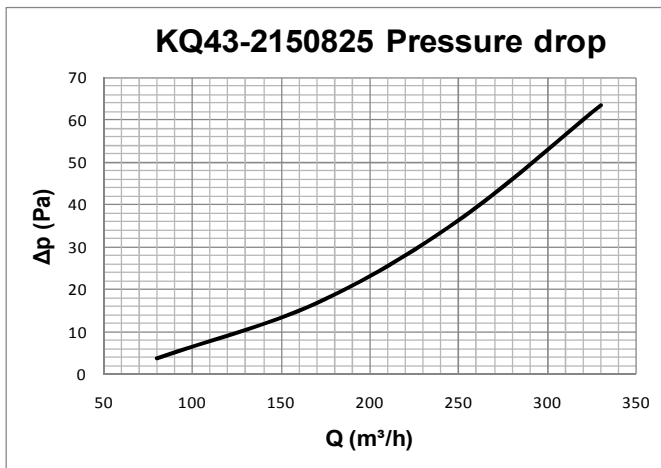

L (m) horizontal distance in metres from the centre of the diffuser
VL (m/s) maximum speed in the air stream

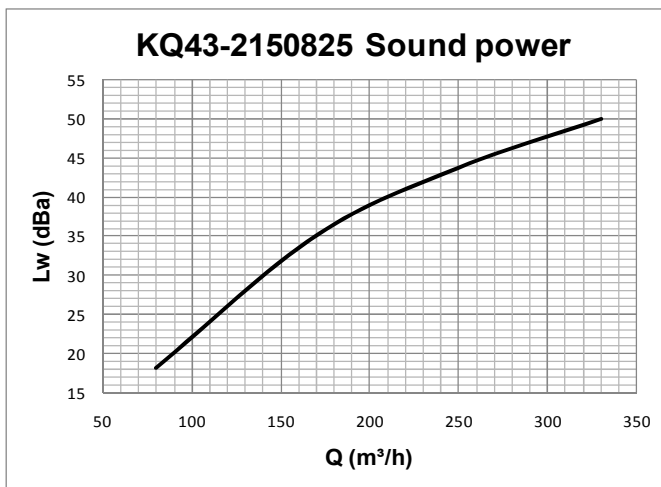

Data measured in reverberation room in accordance with international standards:
ISO 3741 1999: *Acoustic - determination of sound power levels of noise sources using sound pressure - Precision methods for reverberation rooms*

ISO 5135 1997: *Acoustic - determination of sound power levels of noise from air-terminal devices; air terminal units; dampers and valves by measurement in a reverberation room.*

The data presented does not consider the attenuation given by the area of installation. This attenuation is normally between 6 and 10 dBA and is determined by the room size, the shape of the environment and the interior features.



RECTANGULAR HIGH INDUCTION DIFFUSERS

KQ-43
SERIES

PERFORMANCE
KQ43 2151025

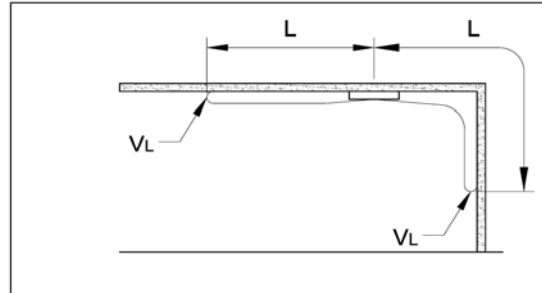
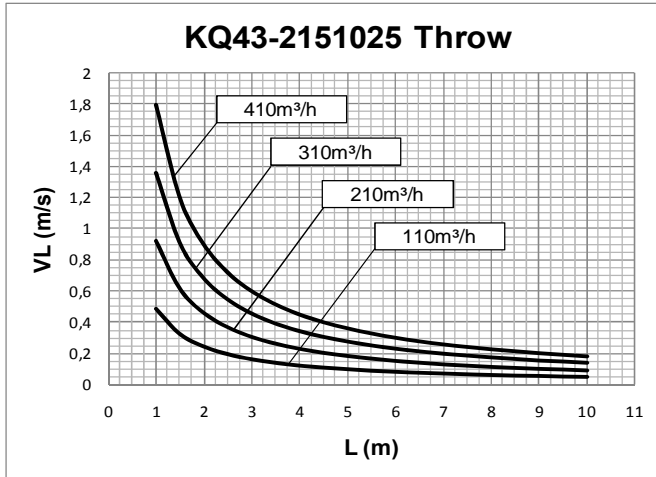

Data measured in isothermic conditions in accordance with international standards:
ISO 5219 1984: *Air distribution and air diffusion - Laboratory. Aerodynamic testing and rating of air terminal devices.*

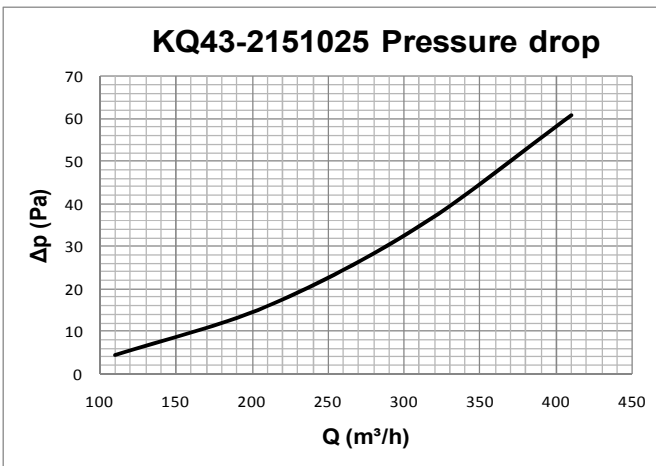

L (m) horizontal distance in metres from the centre of the diffuser

VL (m/s) maximum speed in the air stream

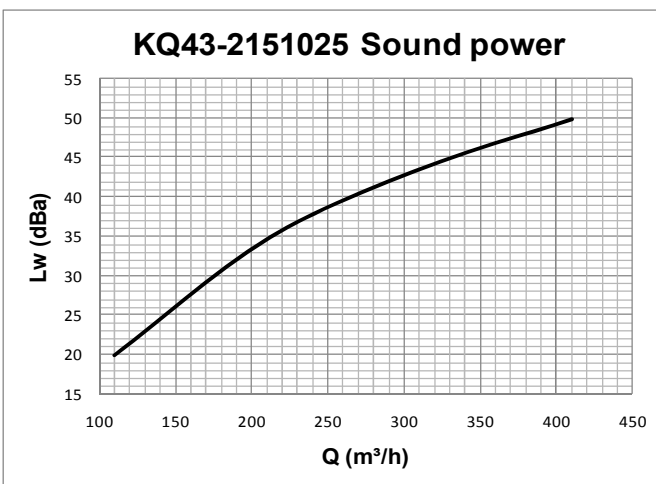

Data measured in reverberation room in accordance with international standards:

ISO 3741 1999: *Acoustic - determination of sound power levels of noise sources using sound pressure - Precision methods for reverberation rooms*

ISO 5135 1997: *Acoustic - determination of sound power levels of noise from air-terminal devices; air terminal units; dampers and valves by measurement in a reverberation room.*

The data presented does not consider the attenuation given by the area of installation. This attenuation is normally between 6 and 10 dBA and is determined by the room size, the shape of the environment and the interior features.



RECTANGULAR HIGH INDUCTION DIFFUSERS

KQ-43
SERIES

PERFORMANCE
KQ43 3150425

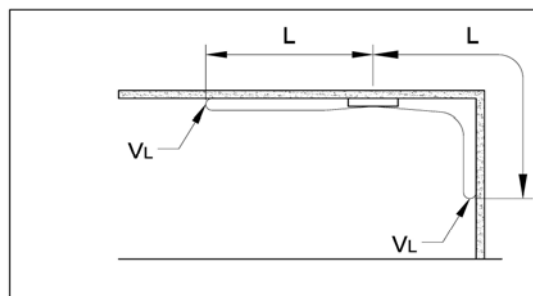
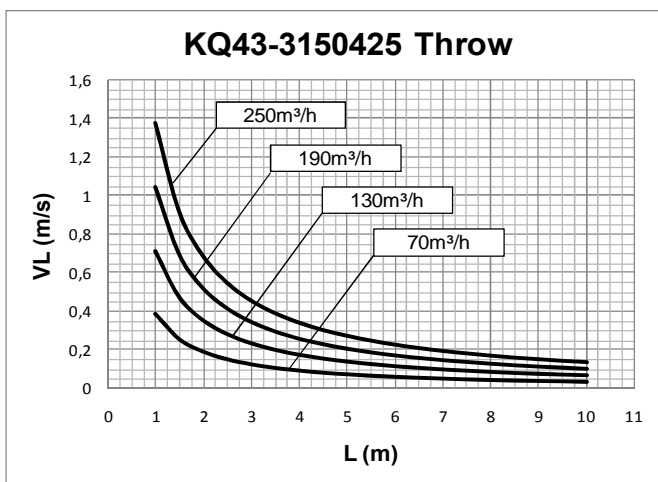

Data measured in isothermic conditions in accordance with international standards:
ISO 5219 1984: *Air distribution and air diffusion - Laboratory. Aerodynamic testing and rating of air terminal devices.*

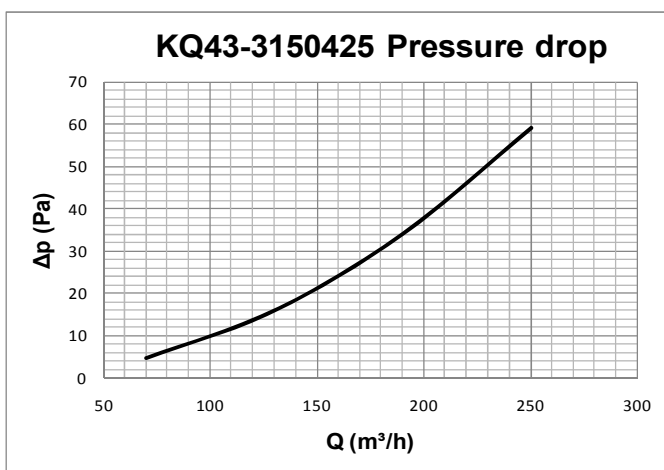

L (m) horizontal distance in metres from the centre of the diffuser
VL (m/s) maximum speed in the air stream

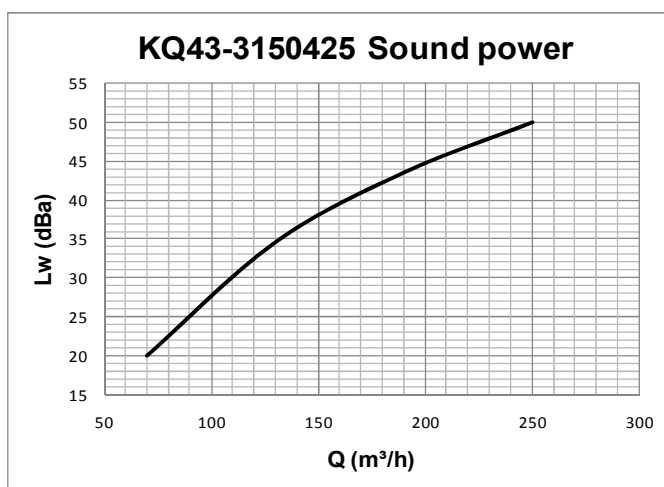

Data measured in reverberation room in accordance with international standards:
ISO 3741 1999: *Acoustic - determination of sound power levels of noise sources using sound pressure - Precision methods for reverberation rooms*

ISO 5135 1997: *Acoustic - determination of sound power levels of noise from air-terminal devices; air terminal units; dampers and valves by measurement in a reverberation room.*

The data presented does not consider the attenuation given by the area of installation. This attenuation is normally between 6 and 10 dBA and is determined by the room size, the shape of the environment and the interior features.



RECTANGULAR HIGH INDUCTION DIFFUSERS

KQ-43
SERIES

PERFORMANCE
KQ43 3150525

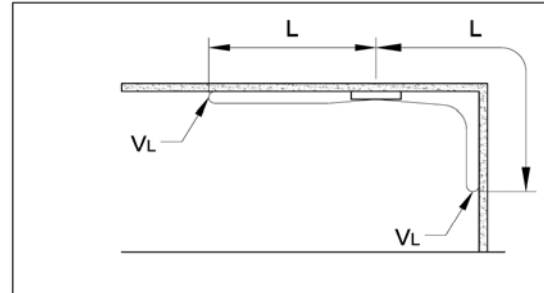
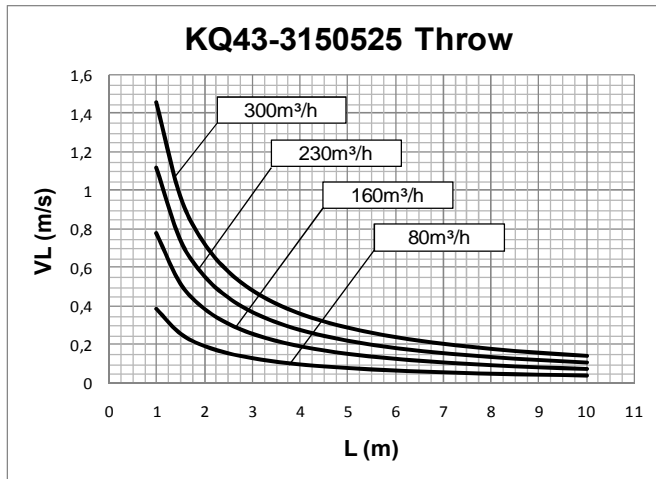

Data measured in isothermic conditions in accordance with international standards:
ISO 5219 1984: *Air distribution and air diffusion - Laboratory. Aerodynamic testing and rating of air terminal devices.*

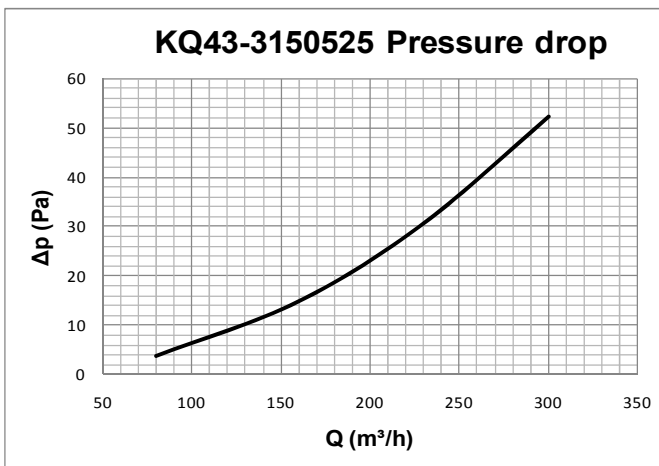

L (m) horizontal distance in metres from the centre of the diffuser
VL (m/s) maximum speed in the air stream

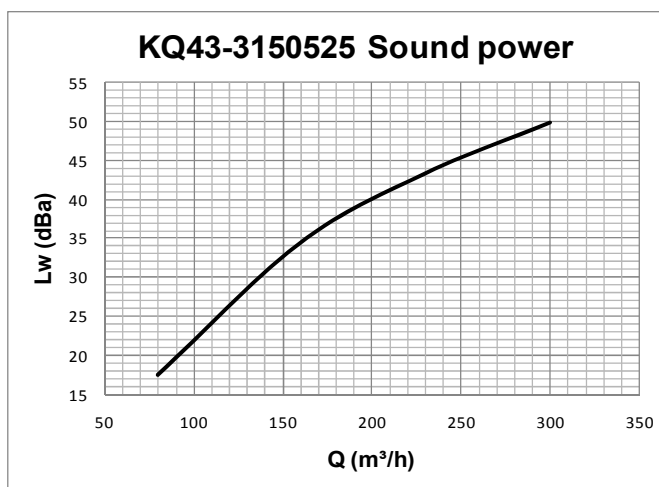

Data measured in reverberation room in accordance with international standards:
ISO 3741 1999: *Acoustic - determination of sound power levels of noise sources using sound pressure - Precision methods for reverberation rooms*

ISO 5135 1997: *Acoustic - determination of sound power levels of noise from air-terminal devices; air terminal units; dampers and valves by measurement in a reverberation room.*

The data presented does not consider the attenuation given by the area of installation. This attenuation is normally between 6 and 10 dBA and is determined by the room size, the shape of the environment and the interior features.



RECTANGULAR HIGH INDUCTION DIFFUSERS

KQ-43
SERIES

PERFORMANCE
KQ43 3150625

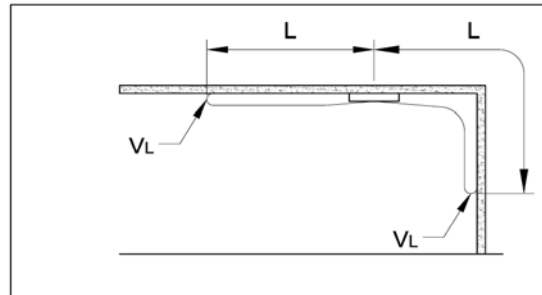
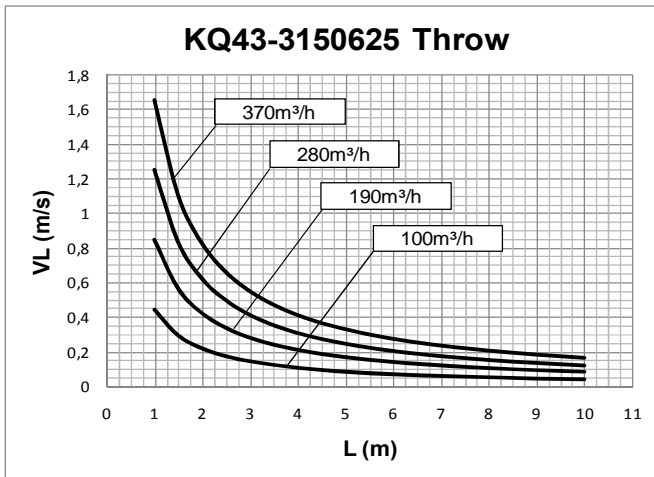

Data measured in isothermic conditions in accordance with international standards:
ISO 5219 1984: *Air distribution and air diffusion - Laboratory. Aerodynamic testing and rating of air terminal devices.*

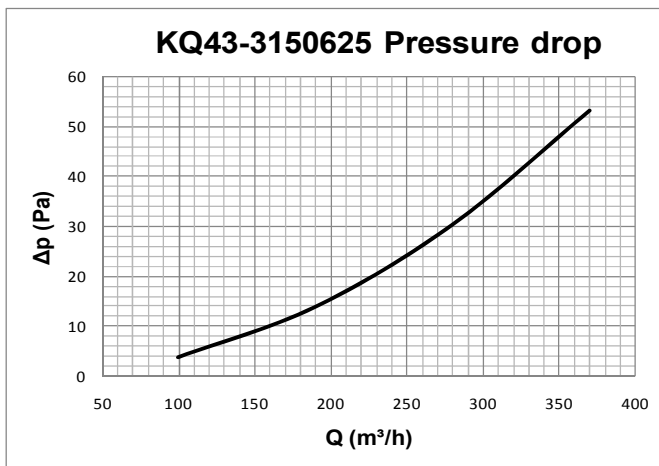

L (m) horizontal distance in metres from the centre of the diffuser
VL (m/s) maximum speed in the air stream

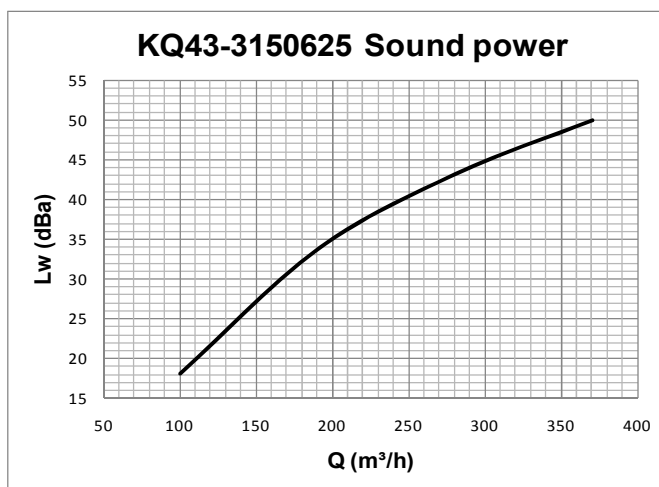

Data measured in reverberation room in accordance with international standards:
ISO 3741 1999: *Acoustic - determination of sound power levels of noise sources using sound pressure - Precision methods for reverberation rooms*

ISO 5135 1997: *Acoustic - determination of sound power levels of noise from air-terminal devices; air terminal units; dampers and valves by measurement in a reverberation room.*

The data presented does not consider the attenuation given by the area of installation. This attenuation is normally between 6 and 10 dBa and is determined by the room size, the shape of the environment and the interior features.



RECTANGULAR HIGH INDUCTION DIFFUSERS

KQ-43
SERIES

PERFORMANCE
KQ43 3150825

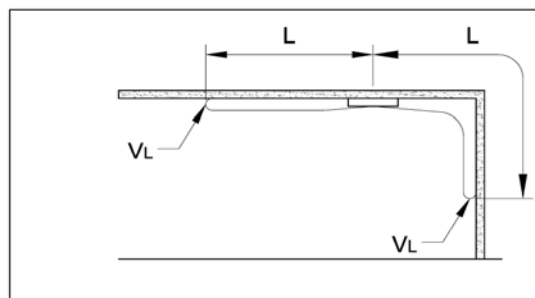
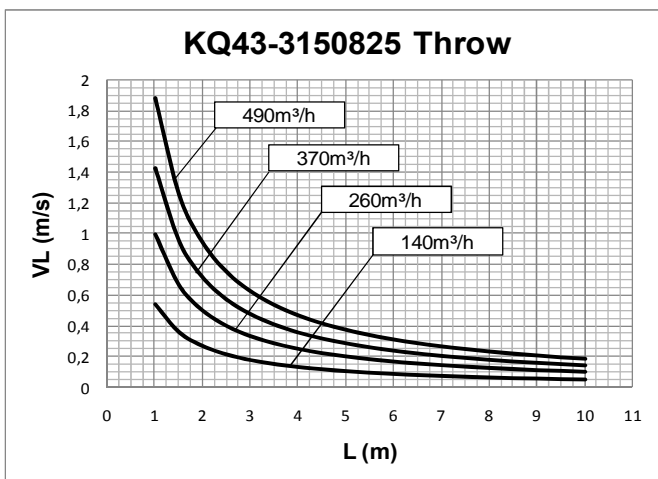

Data measured in isothermic conditions in accordance with international standards:
ISO 5219 1984: *Air distribution and air diffusion - Laboratory. Aerodynamic testing and rating of air terminal devices.*

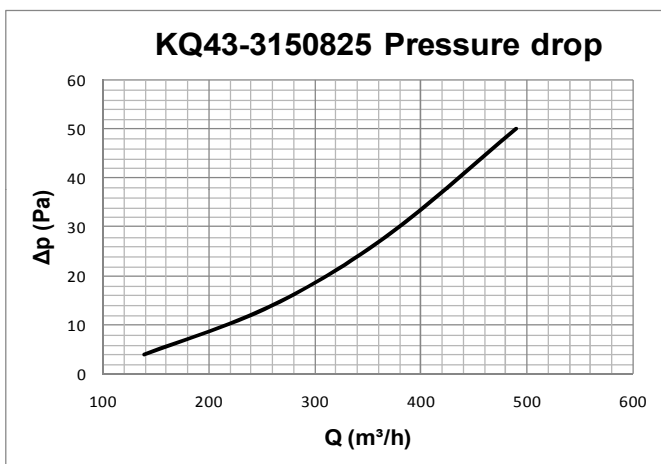

L (m) horizontal distance in metres from the centre of the diffuser
 V_L (m/s) maximum speed in the air stream

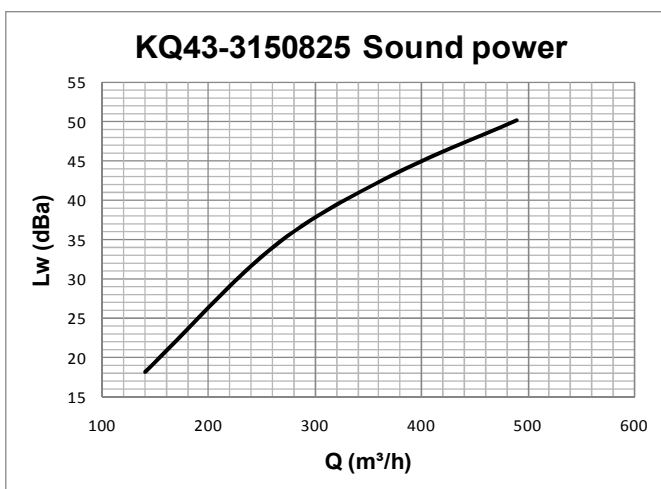

Data measured in reverberation room in accordance with international standards:
ISO 3741 1999: *Acoustic - determination of sound power levels of noise sources using sound pressure - Precision methods for reverberation rooms*

ISO 5135 1997: *Acoustic - determination of sound power levels of noise from air-terminal devices; air terminal units; dampers and valves by measurement in a reverberation room.*

The data presented does not consider the attenuation given by the area of installation. This attenuation is normally between 6 and 10 dBA and is determined by the room size, the shape of the environment and the interior features.



RECTANGULAR HIGH INDUCTION DIFFUSERS

KQ-43
SERIES

PERFORMANCE
KQ43 3151025

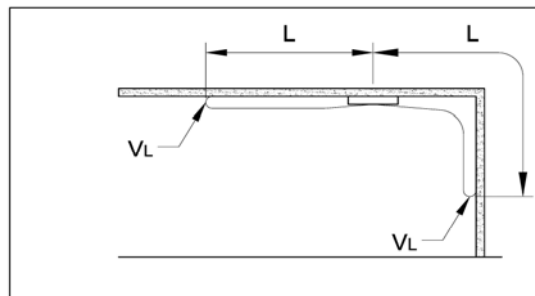
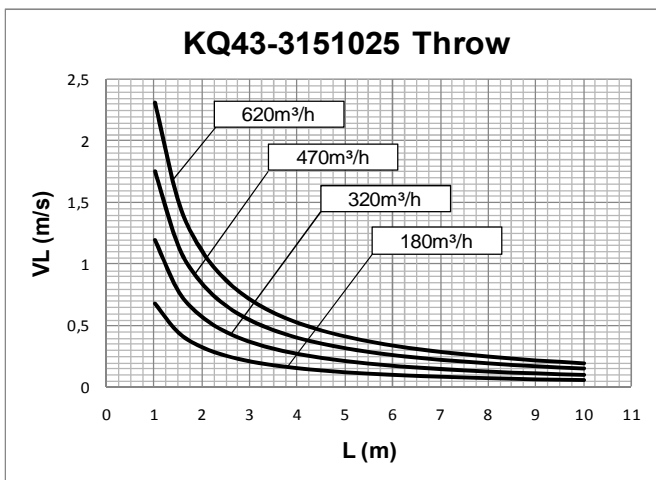

Data measured in isothermic conditions in accordance with international standards:
ISO 5219 1984: *Air distribution and air diffusion - Laboratory. Aerodynamic testing and rating of air terminal devices.*

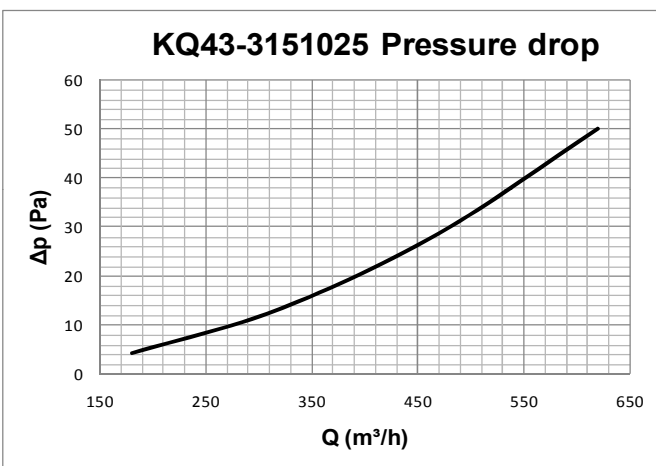

L (m) horizontal distance in metres from the centre of the diffuser
VL (m/s) maximum speed in the air stream

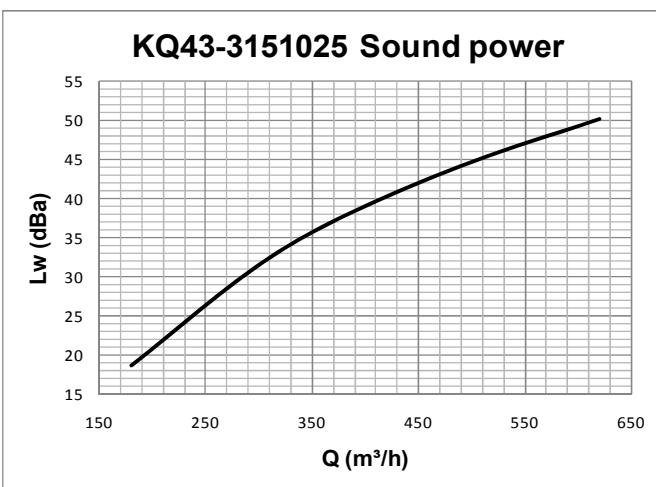

Data measured in reverberation room in accordance with international standards:
ISO 3741 1999: *Acoustic - determination of sound power levels of noise sources using sound pressure - Precision methods for reverberation rooms*

ISO 5135 1997: *Acoustic - determination of sound power levels of noise from air-terminal devices; air terminal units; dampers and valves by measurement in a reverberation room.*

The data presented does not consider the attenuation given by the area of installation. This attenuation is normally between 6 and 10 dBa and is determined by the room size, the shape of the environment and the interior features.



RECTANGULAR HIGH INDUCTION DIFFUSERS

PP20
PP21
SERIES

PLENUM

OVERVIEW :

The plenums for the KQ423 diffusers are in galvanised steel sheeting and can be supplied with damper and equaliser.

TECHNICAL DIAGRAMS :

PP 20 - PLENUM WITH LATERAL CONNECTION

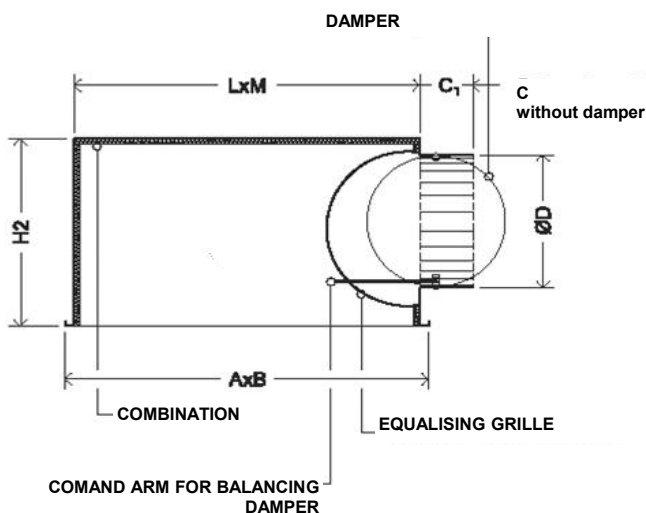

PP 21 - PLENUM WITH CONNECTION ABOVE

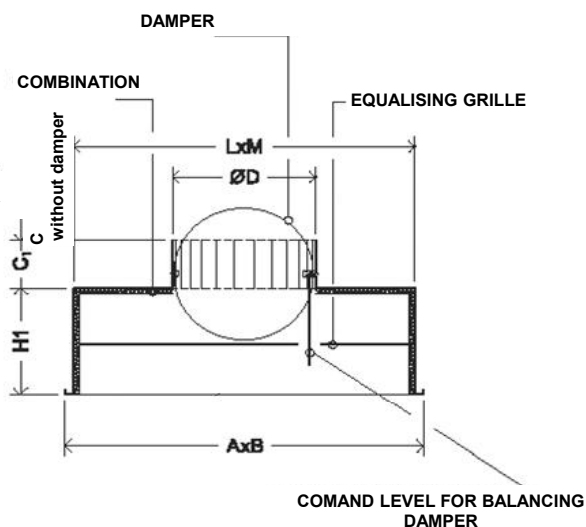

Plenum	Panel Dimensions	A x B	LxM	C	C1	Ø D	H1	H2	connecton material
PP20 - 115 x 425	150x450	144x444	114x414	65	65	96	200	300	steel
PP20 - 115 x 525	150x550	144x544	114x514	65	65	96	200	300	steel
PP20 - 115 x 625	150x650	144x644	114x614	60	90	121	200	300	ABS (*)
PP20 - 115 x 825	150x850	144x844	114x814	60	90	156	200	350	ABS (*)
PP20 - 115 x 1025	150x1050	144x1044	114x1014	60	90	196	200	350	ABS (*)
PP20 - 215 x 425	250x450	244x444	214x414	60	90	121	200	350	ABS (*)
PP20 - 215 x 525	250x550	244x544	214x514	60	90	156	200	350	ABS (*)
PP20 - 215 x 625	250x650	244x644	214x614	60	90	156	200	350	ABS (*)
PP20 - 215 x 825	250x850	244x844	214x814	60	90	196	200	350	ABS (*)
PP20 - 215 x 1025	250x1050	244x1044	214x1014	60	90	196	200	350	ABS (*)
PP20 - 315 x 425	350x450	344x444	314x414	60	90	156	200	350	ABS (*)
PP20 - 315 x 525	350x550	344x544	314x514	60	90	156	200	350	ABS (*)
PP20 - 315 x 625	350x650	344x644	314x614	60	90	196	200	350	ABS (*)
PP20 - 315 x 825	350x850	344x844	314x814	60	90	246	250	350	ABS (*)
PP20 - 315 x 1025	350x1050	344x1044	314x1014	60	90	246	250	350	ABS (*)

(*) Steel on request



RECTANGULAR HIGH INDUCTION DIFFUSERS

PP20
PP21
SERIES

PLENUM

