



HIGH INDUCTION DIFFUSERS WITH VARIABLE GEOMETRY

KQ - 40
KQ - 42
SERIES

OVERVIEW
CHARACTERISTICS
APPLICATIONS

OVERVIEW :

KQ high-induction diffusers with variable geometry are a new solution for air diffusion devices. The unique control system of deflector elements allows their application both in cooling and heating. In fact, the possibility of varying the geometry of the fining, allows the modification of the component configuration and its adaptation to the optimal throw conditions. In this way it is avoided the phenomenon of stratification, which does not allow the maintenance of optimal climatic conditions in the occupied area, that the formation of cold currents in the case of cooling, unequivocal symptom of the fact that the air introduced reaches the occupied area with speed superior to those of well-being.

The versatility of this range of components is certainly the most significant attribute in all those civil applications where there are strong changes in thermal loads and where the required launches can be substantial.

The variety of sizes available allows applications with a wide range of air flow rates, launches and temperature differentials between primary air and ambient air.

Within this range the KQ diffusers guarantee a correct air speed in the occupied area, ensuring uniform temperature and total absence of irregular and unpleasant drafts.

The problems of false ceiling installation are perfectly solved in the models that can be realized with a 595x595 panel, in the dimensions that constructively allow this solution.

APPLICATIONS :

The diffuser is designed for civil applications with any type of mixing ventilation plants and should be installed at heights between 3,0 and 4,5 meters. The high induction diffuser with variable geometry, which can be changed during operation, can set flows between 50 and 1700 m³/h with variable temperature gradients ranging from +15 °C and -10 °C.

MATERIALS

Carbon steel panel painted white RAL9010

White polypropylene nozzles.

Possibility of producing AISI 304 or AISI 316 stainless steel versions with gloss or satin finish.

UNSUITABLE ENVIRONMENTS

The products in painted carbon steel are not suitable for installation in environments with high humidity and in environments with a potentially explosive atmosphere or containing powders or vapors of corrosive substances.



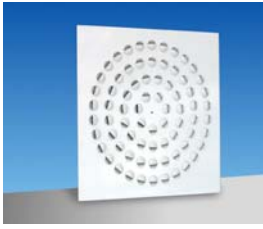

HIGH INDUCTION DIFFUSERS WITH VARIABLE GEOMETRY

KQ - 40
KQ - 42
SERIES

Ak in m²

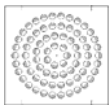
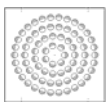
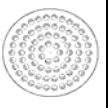
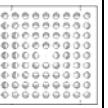
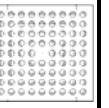
NOMINAL DIMENSIONS						
DIMENSIONS	n° nozzles	KQ 40	KQ 40 T	KQ 40 R	KQ 42	KQ 42 T
400 x 400	22	0,0057	0,0057	0,0057		
400 x 400	24				0,0062	0,0062
500 x 500	44	0,0114	0,0114	0,0114		
500 x 500	48				0,0124	0,0124
600 x 600	74	0,0191		0,0191		
600 x 600	80				0,0206	
625 x 625	74	0,0191		0,0191		
625 x 625	80				0,0206	

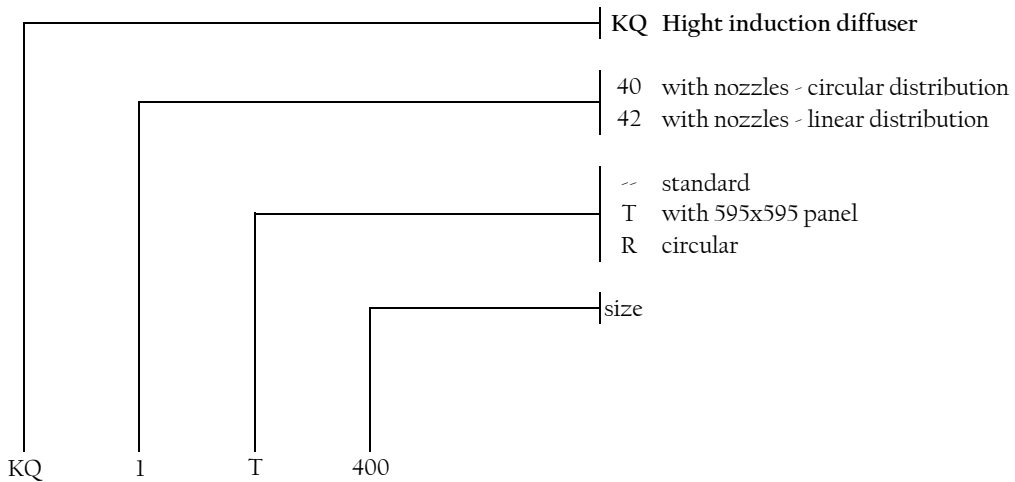



HIGH INDUCTION DIFFUSERS WITH VARIABLE GEOMETRY

KQ - 40
KQ - 42
SERIES



OVERVIEW TECHNICAL CHARACTERISTICS

The hallmark of KQ 40-42 series high induction diffusers is their modern design and their range of individually-adjustable jets. This system enables you to manage vertical, horizontal, and combined air throws, as well as radial air throws with a coanda effect or swirl motion, plus one-way, two-way, three-way, and for-way air throws. The diffuser's 360° operational field ensures high induction and enables the terminal to be used on both constant-delivery and variable-delivery plants. KQ 40 - 42 series diffusers also have a plenum fitted with air balancing and equalising shutters. The external panel is made from carbon steel sheet, coated with RAL 9010 white epoxy-powder paint, and the jets are made of RAL 9010 white plastic.

KQ40 CIRCULAR DIFFUSER - 4 RINGS - UP TO MAXIMUM 74 NOZZLES. DIMENSIONS 300x300 400x400 500X500 600X600 625X625

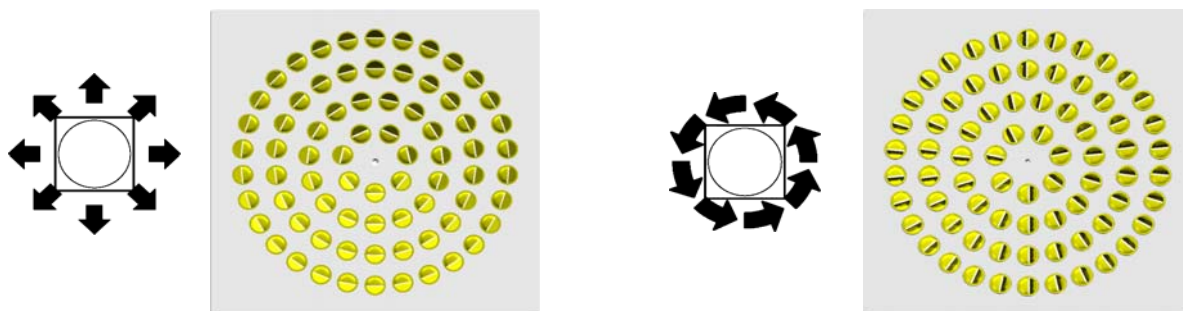

KQ42 SQUARE DIFFUSER - 4 DIRECTIONS, UP TO A MAXIMUM OF 80 RINGLETS.
AVILABLE SIZES 400x400 500X500 600X600 625X625

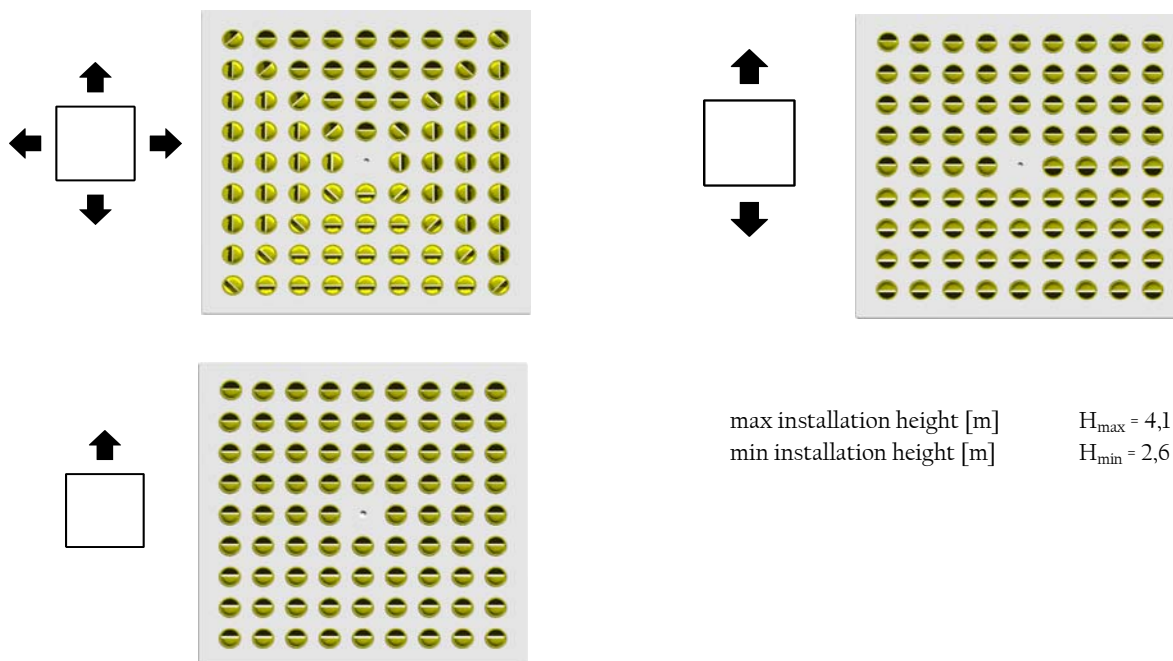

max installation height [m] $H_{max} = 4,1$ m
min installation height [m] $H_{min} = 2,6$ m

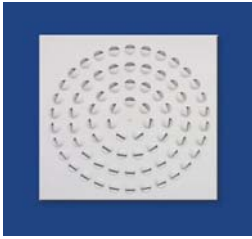

HIGH INDUCTION DIFFUSERS WITH VARIABLE GEOMETRY

KQ - 40
SERIES

PERFORMANCE KQ40-400
MULTIDIRECTIONAL THROW

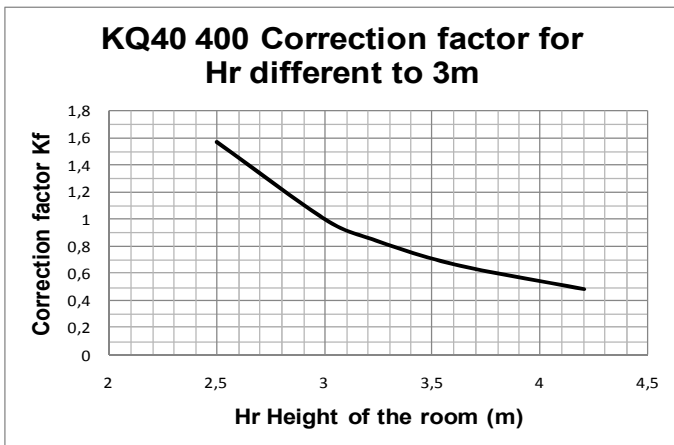
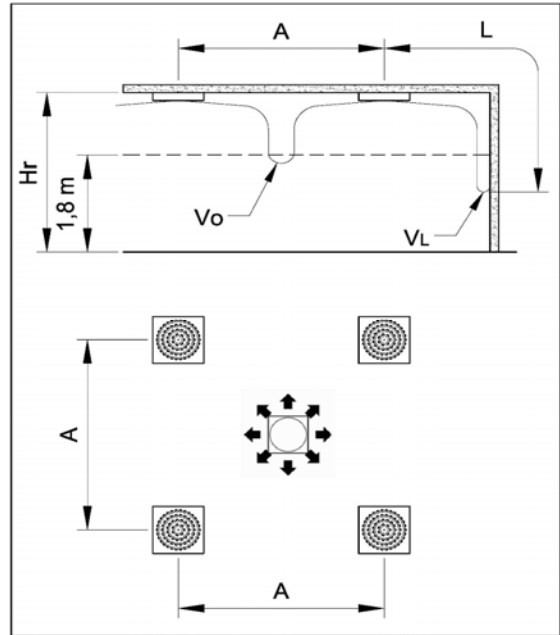
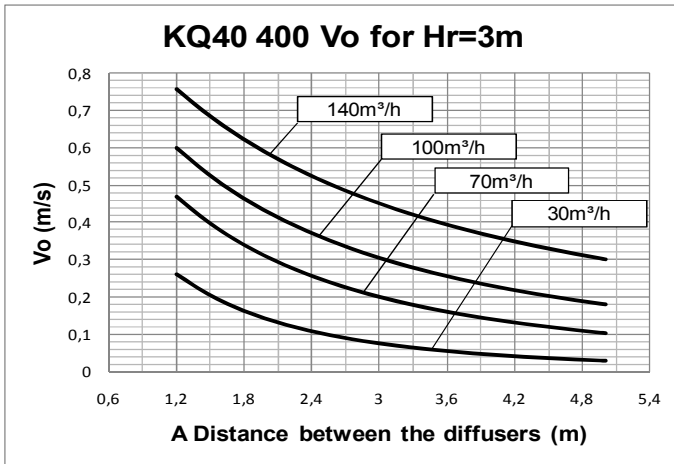

Data measured in isothermic conditions in accordance with international standards:
ISO 5219 1984: Air distribution and air diffusion - Laboratory. Aerodynamic testing and rating of air terminal devices.

A(m) distance between thwe diffusers
Vo (m/s) speed at the limit of the occupied zone
L (m) horizontal distance in metres from the centre of the diffuser
VL (m/s) maximum speed in the air stream

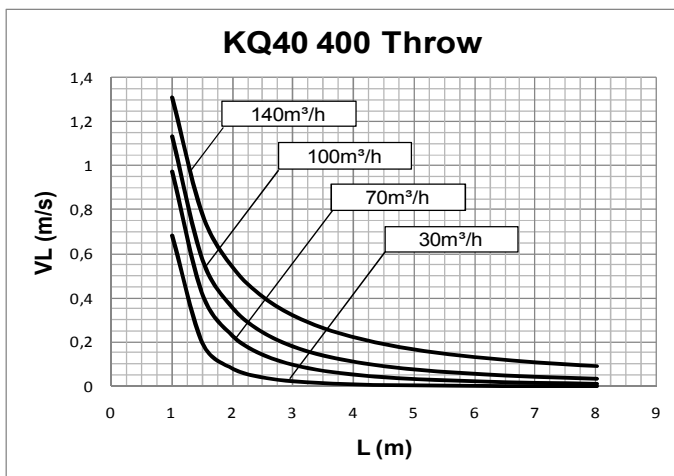

For Hr different from 3m:
 $V_o(h) = V_o \times K_f$

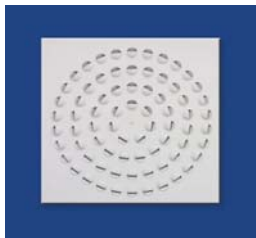

HIGH INDUCTION DIFFUSERS WITH VARIABLE GEOMETRY

KQ - 40
SERIES

PERFORMANCE KQ40-400
SPIRAL THROW

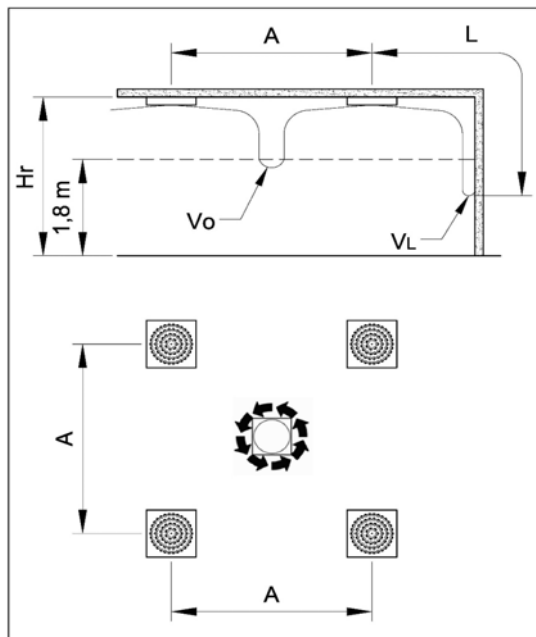
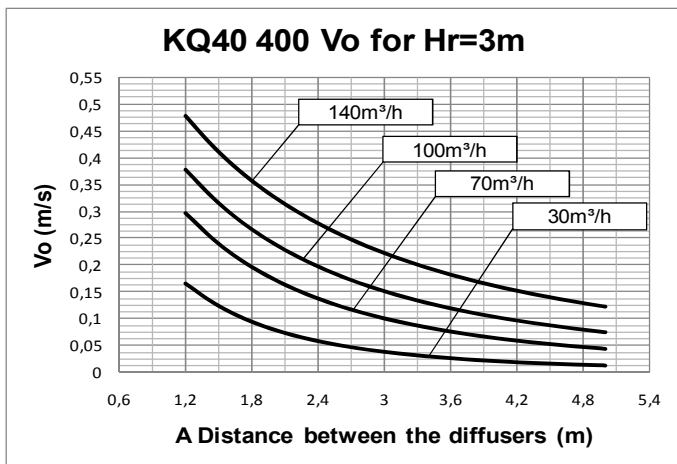

Data measured in isothermic conditions in accordance with international standards: ISO 5219 1984: Air distribution and air diffusion - Laboratory. Aerodynamic testing and rating of air terminal devices.

A(m) distance between thwe diffusers
Vo (m/s) speed at the limit of the occupied zone
L (m) horizontal distance in metres from the centre of the diffuser
VL (m/s) maximum speed in the air stream

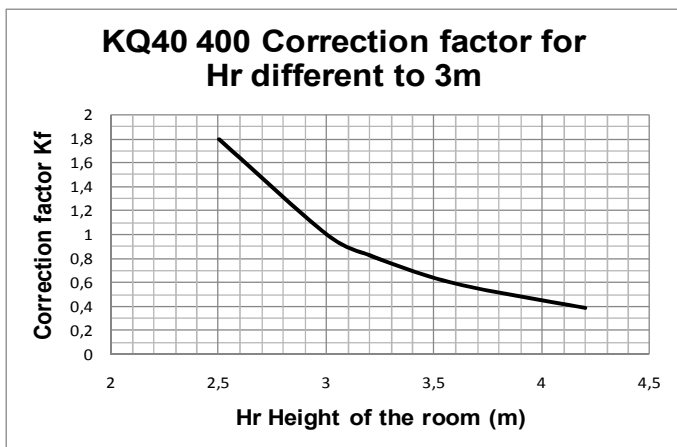

For Hr different from 3m:
 $V_o(h) = V_o \times K_f$

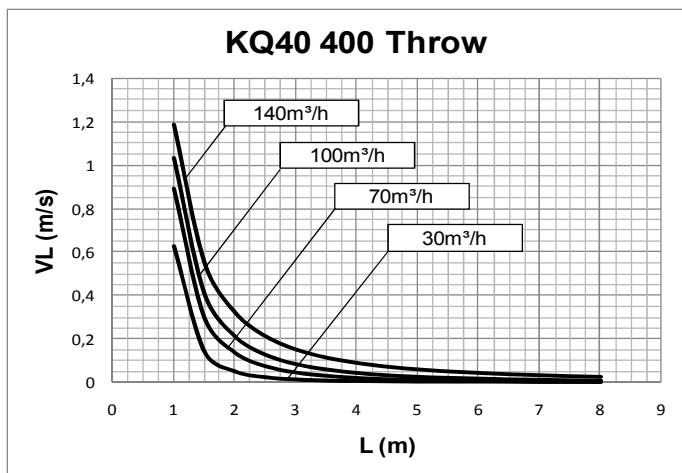



HIGH INDUCTION DIFFUSERS WITH VARIABLE GEOMETRY

KQ - 40
SERIES

PERFORMANCE KQ40-400

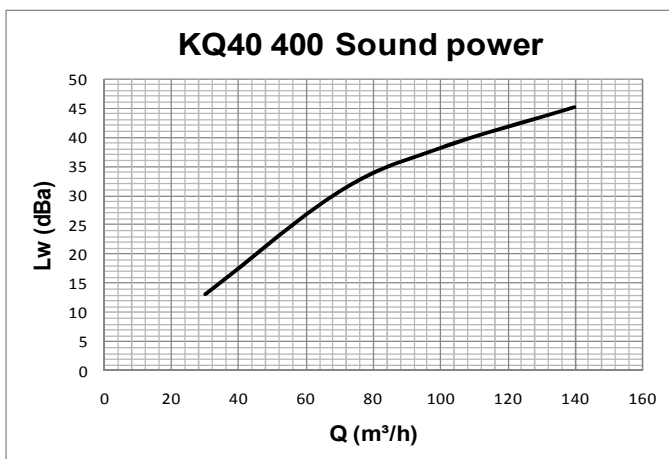

Data measured in reverberation room in accordance with international standards:

ISO 3741 1999: *Acoustic - determination of sound power levels of noise sources using sound pressure - Precision methods for reverberation rooms*

ISO 5135 1997: *Acoustic - determination of sound power levels of noise from air-terminal devices ; air terminal units; dampers and valves by measurement in a reverberation room.*

The data presented does not consider the attenuation given by the area of installation. This attenuation is normally between 6 and 10 dBA and is determined by the room size, the shape of the environment and the interior features.

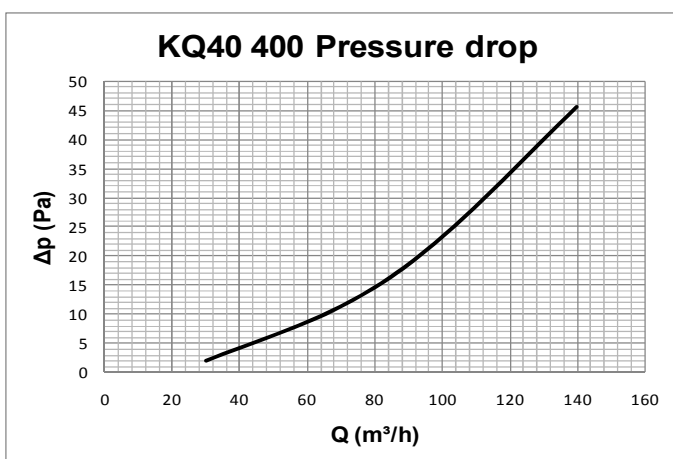

Data measured in isothermic conditions in accordance with international standards:

ISO 5219 1984: *Air distribution and air diffusion - Laboratory. Aerodynamic testing and rating of air terminal devices.*

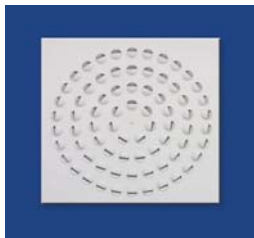

HIGH INDUCTION DIFFUSERS WITH VARIABLE GEOMETRY

KQ - 40
SERIES

PERFORMANCE KQ40-500
MULTIDIRECTIONAL THROW

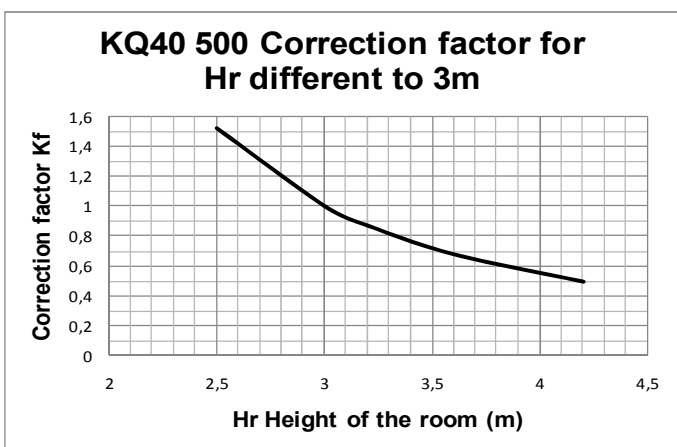
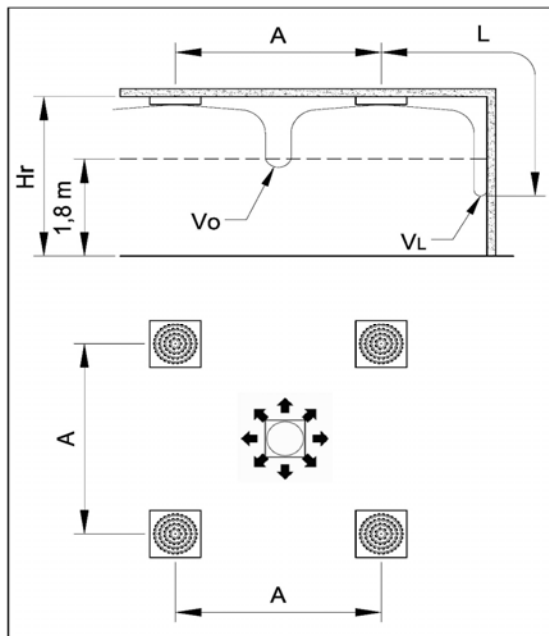
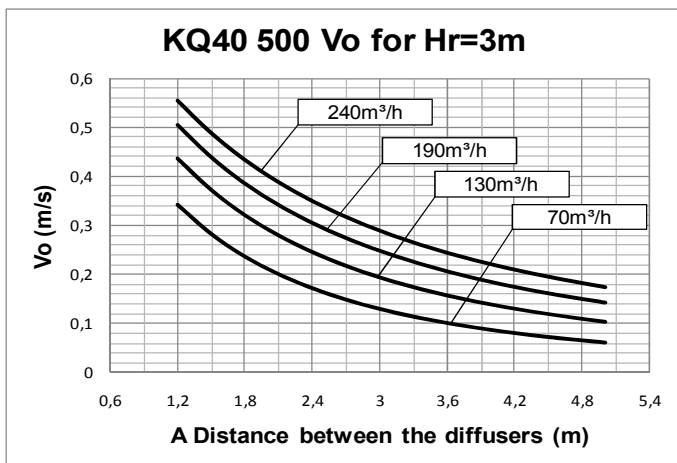

Data measured in isothermic conditions in accordance with international standards:
ISO 5219 1984: Air distribution and air diffusion - Laboratory. Aerodynamic testing and rating of air terminal devices.

A(m) distance between thwe diffusers
Vo (m/s) speed at the limit of the occupied zone
L (m) horizontal distance in metres from the centre of the diffuser
VL (m/s) maximum speed in the air stream

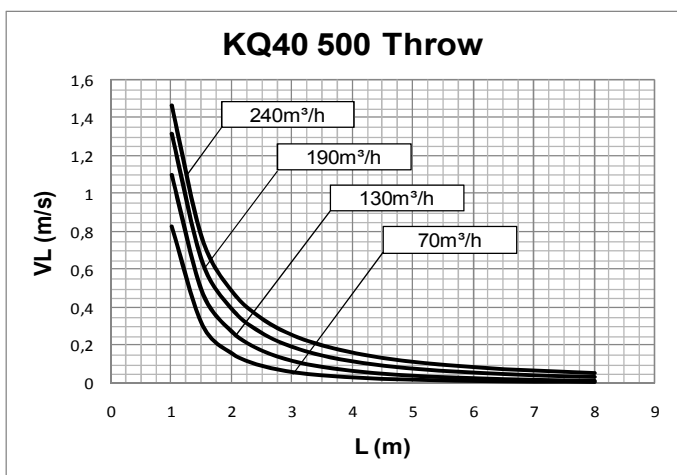

For Hr different from 3m:
 $V_o(h) = V_o \times K_f$

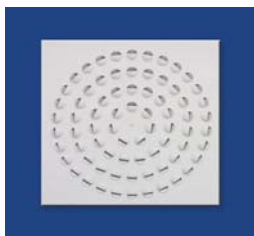

HIGH INDUCTION DIFFUSERS WITH VARIABLE GEOMETRY

KQ - 40
SERIES

PERFORMANCE KQ40-500
SPIRAL THROW

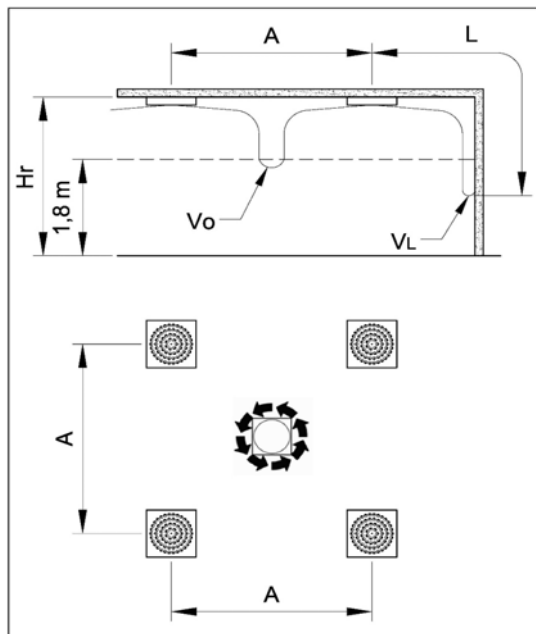
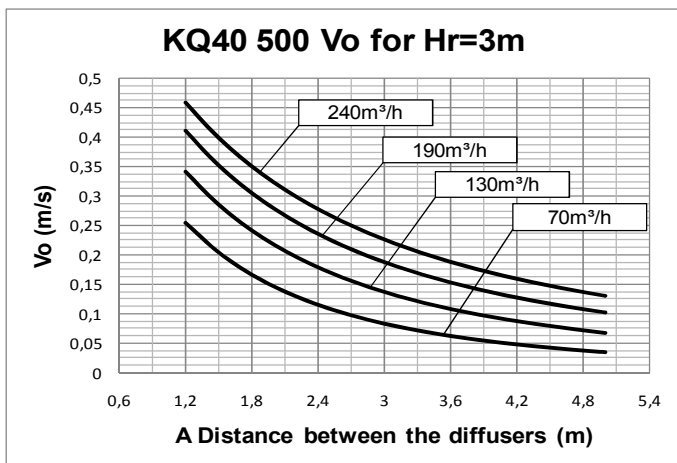

Data measured in isothermic conditions in accordance with international standards: ISO 5219 1984: Air distribution and air diffusion - Laboratory. Aerodynamic testing and rating of air terminal devices.

A(m) distance between thwe diffusers
Vo (m/s) speed at the limit of the occupied zone
L (m) horizontal distance in metres from the centre of the diffuser
VL (m/s) maximum speed in the air stream

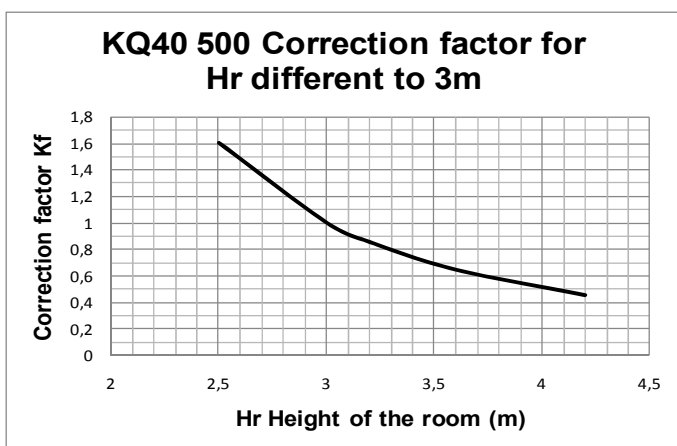

For Hr different from 3m:
 $V_o(h) = V_o \times K_f$

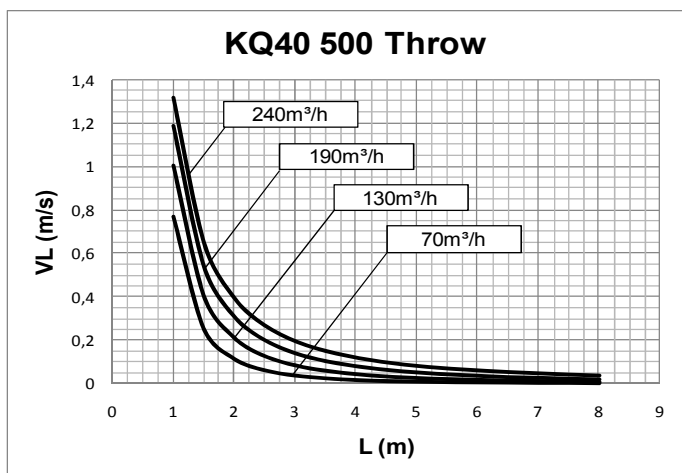

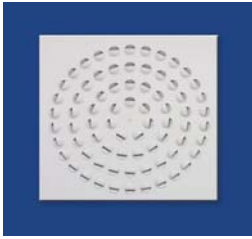

HIGH INDUCTION DIFFUSERS WITH VARIABLE GEOMETRY

KQ - 40
SERIES

PERFORMANCE KQ40-500

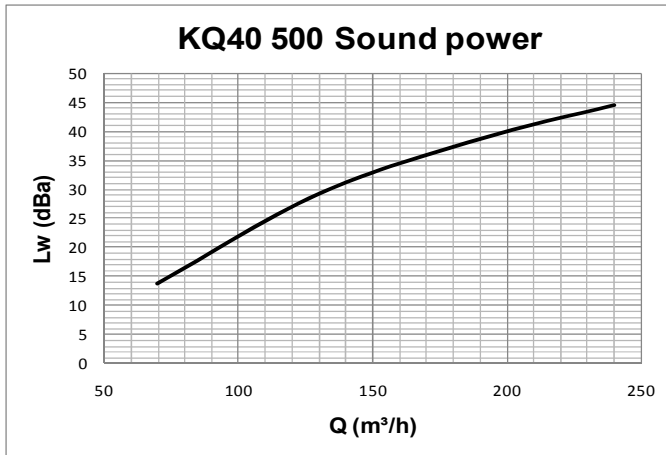

Data measured in reverberation room in accordance with international standards:

ISO 3741 1999: *Acoustic - determination of sound power levels of noise sources using sound pressure - Precision methods for reverberation rooms*

ISO 5135 1997: *Acoustic - determination of sound power levels of noise from air-terminal devices ; air terminal units; dampers and valves by measurement in a reverberation room.*

The data presented does not consider the attenuation given by the area of installation. This attenuation is normally between 6 and 10 dBA and is determined by the room size, the shape of the environment and the interior features.

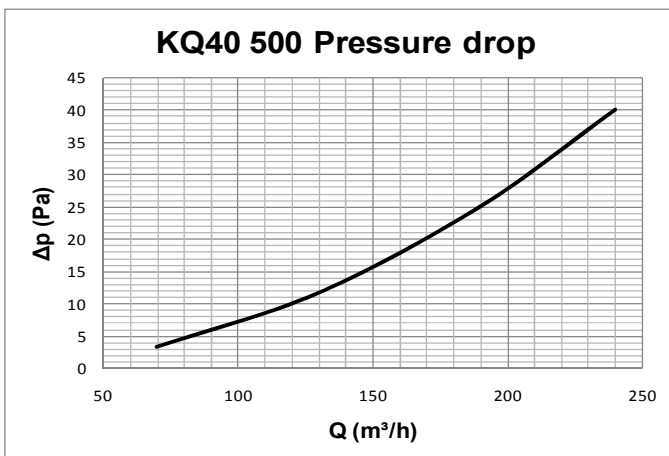

Data measured in isothermic conditions in accordance with international standards:

ISO 5219 1984: *Air distribution and air diffusion - Laboratory. Aerodynamic testing and rating of air terminal devices.*

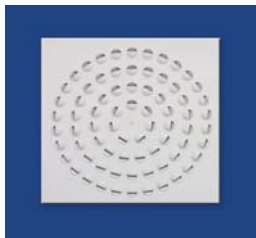

HIGH INDUCTION DIFFUSERS WITH VARIABLE GEOMETRY

KQ - 40
SERIES

PERFORMANCE KQ40-600/625
MULTIDIRECTIONAL THROW

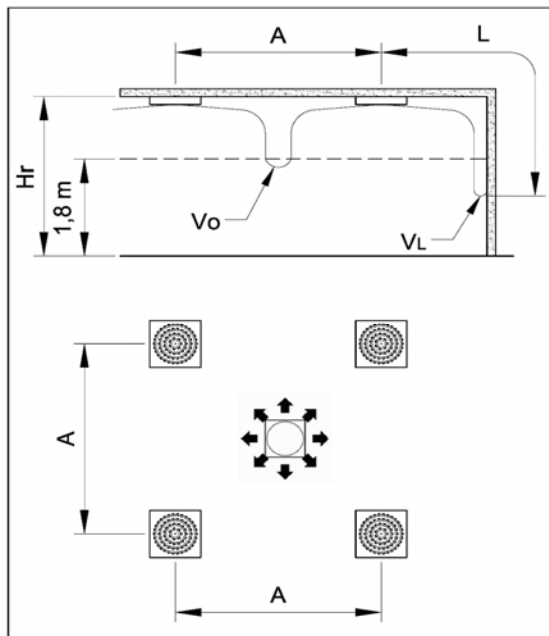
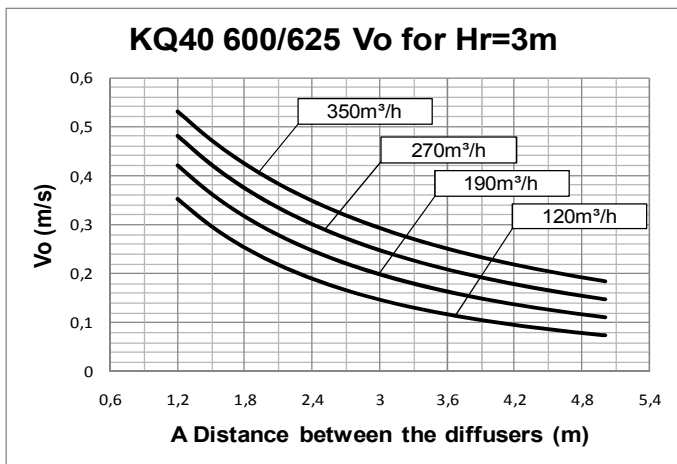

Data measured in isothermic conditions in accordance with international standards:
ISO 5219 1984: Air distribution and air diffusion - Laboratory. Aerodynamic testing and rating of air terminal devices.

A(m) distance between thwe diffusers
Vo (m/s) speed at the limit of the occupied zone
L (m) horizontal distance in metres from the centre of the diffuser
VL (m/s) maximum speed in the air stream

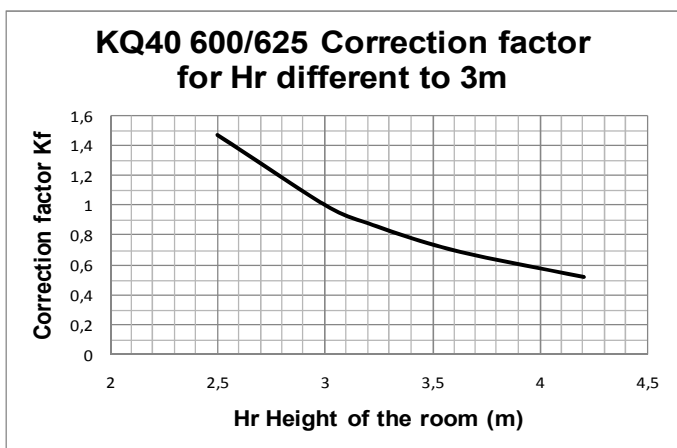

For Hr different from 3m:
 $V_o(h) = V_o \times K_f$

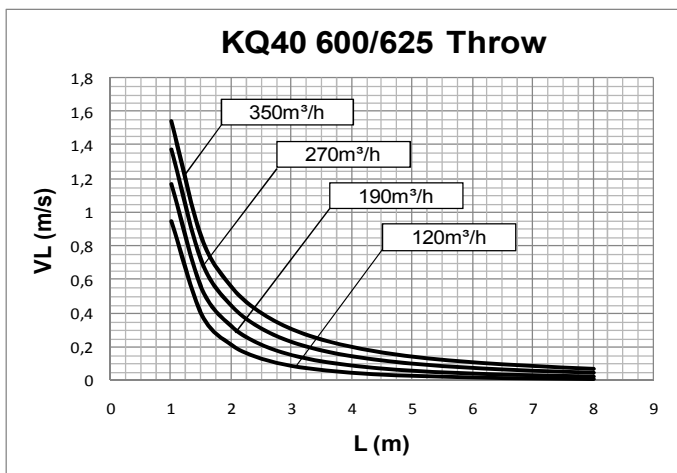

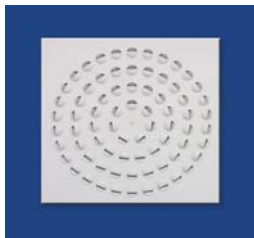

HIGH INDUCTION DIFFUSERS WITH VARIABLE GEOMETRY

KQ - 40
SERIES

PERFORMANCE KQ40-600/625
SPIRAL THROW

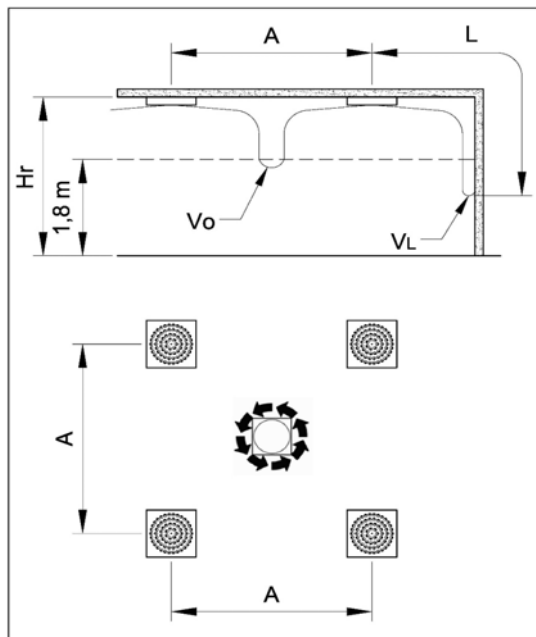
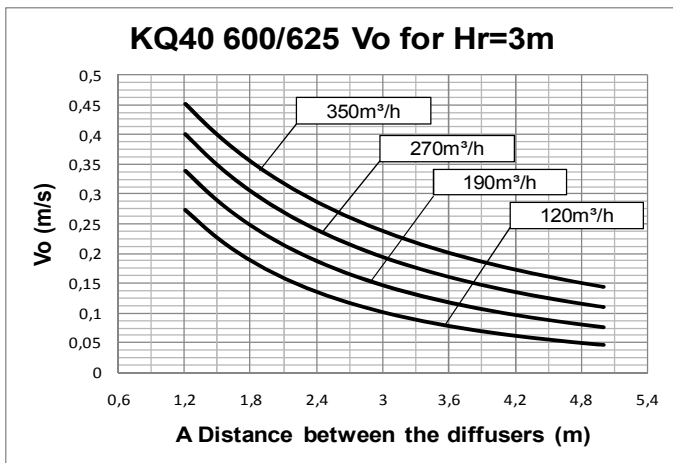

Data measured in isothermic conditions in accordance with international standards: ISO 5219 1984: Air distribution and air diffusion - Laboratory. Aerodynamic testing and rating of air terminal devices.

A(m) distance between the diffusers
Vo (m/s) speed at the limit of the occupied zone
L (m) horizontal distance in metres from the centre of the diffuser
VL (m/s) maximum speed in the air stream

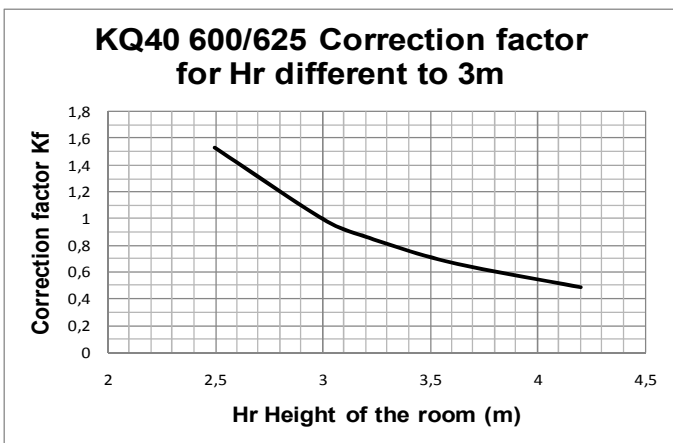

For Hr different from 3m:
 $V_o(h) = V_o \times K_f$

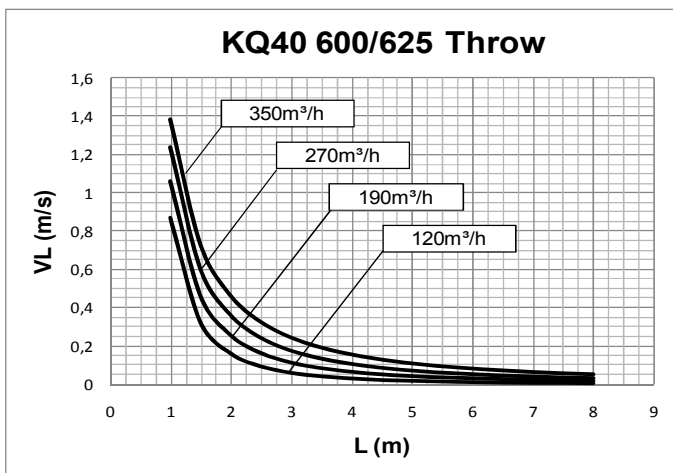

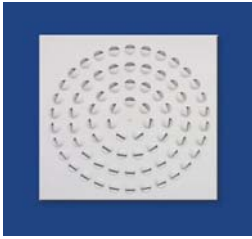

HIGH INDUCTION DIFFUSERS WITH VARIABLE GEOMETRY

PERFORMANCE KQ40-600/625

KQ - 40
SERIES

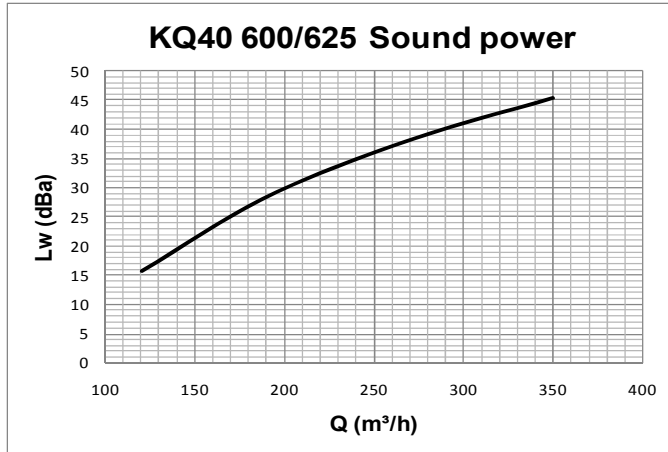

Data measured in reverberation room in accordance with international standards:

ISO 3741 1999: *Acoustic - determination of sound power levels of noise sources using sound pressure - Precision methods for reverberation rooms*

ISO 5135 1997: *Acoustic - determination of sound power levels of noise from air-terminal devices ; air terminal units; dampers and valves by measurement in a reverberation room.*

The data presented does not consider the attenuation given by the area of installation. This attenuation is normally between 6 and 10 dBA and is determined by the room size, the shape of the environment and the interior features.

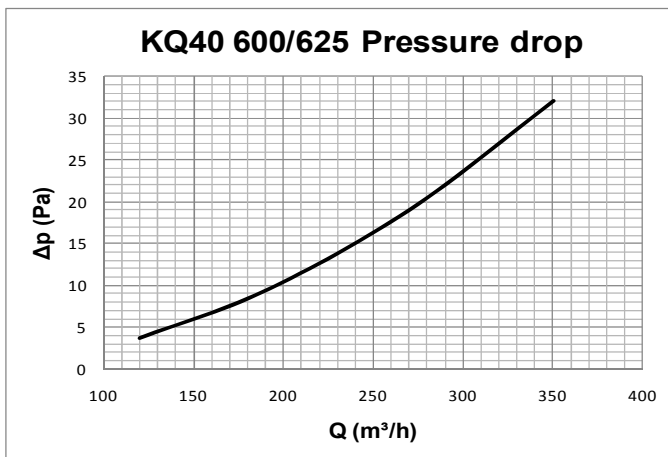

Data measured in isothermic conditions in accordance with international standards:

ISO 5219 1984: *Air distribution and air diffusion - Laboratory. Aerodynamic testing and rating of air terminal devices.*



HIGH INDUCTION DIFFUSERS WITH VARIABLE GEOMETRY

KQ-42
SERIES

PERFORMANCE KQ42-400
MULTIDIRECTIONAL THROW

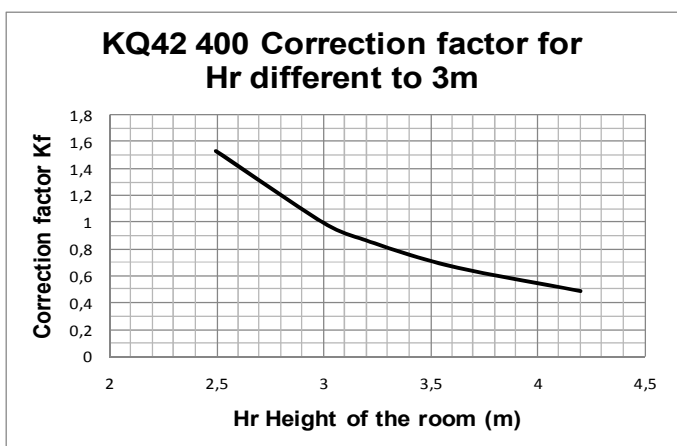
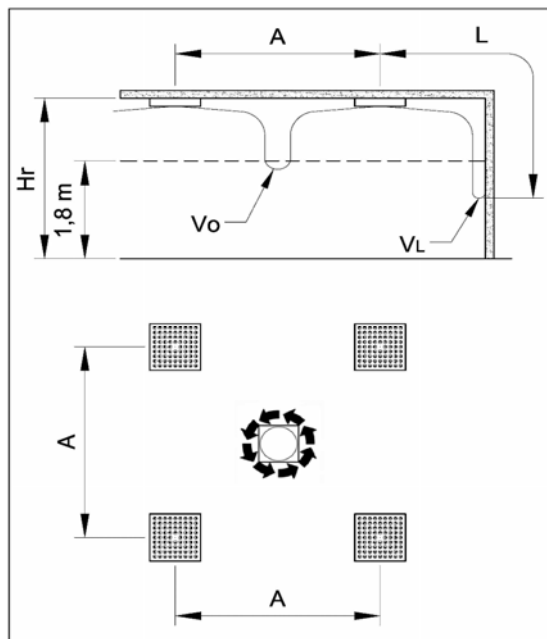
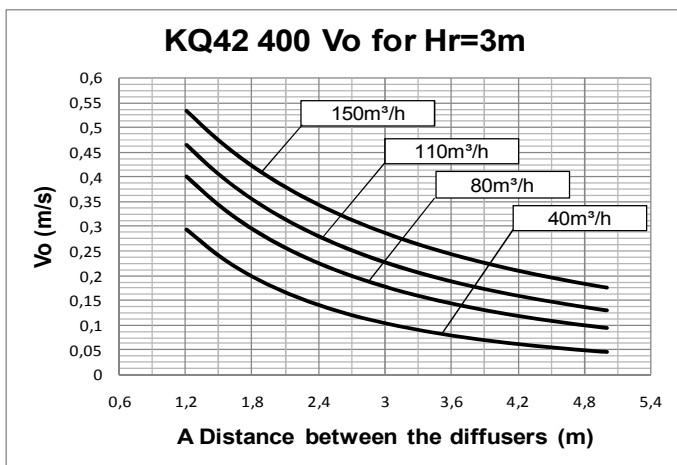

Data measured in isothermic conditions in accordance with international standards:
ISO 5219 1984: Air distribution and air diffusion - Laboratory. Aerodynamic testing and rating of air terminal devices.

A(m) distance between thwe diffusers
Vo (m/s) speed at the limit of the occupied zone
L (m) horizontal distance in metres from the centre of the diffuser
VL (m/s) maximum speed in the air stream

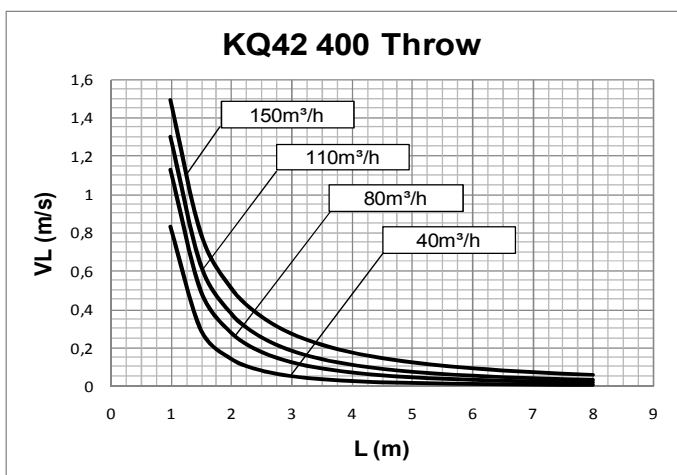

For Hr different from 3m:
 $V_o(h) = V_o \times K_f$



HIGH INDUCTION DIFFUSERS WITH VARIABLE GEOMETRY

KQ-42
SERIES

PERFORMANCE KQ42-400
SPIRAL THROW

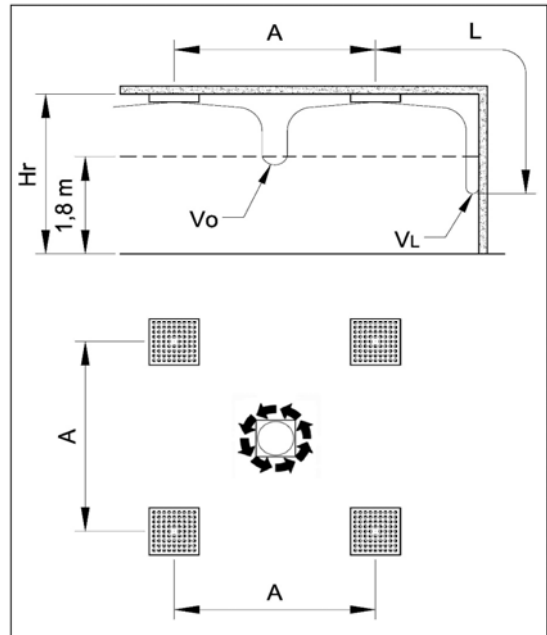
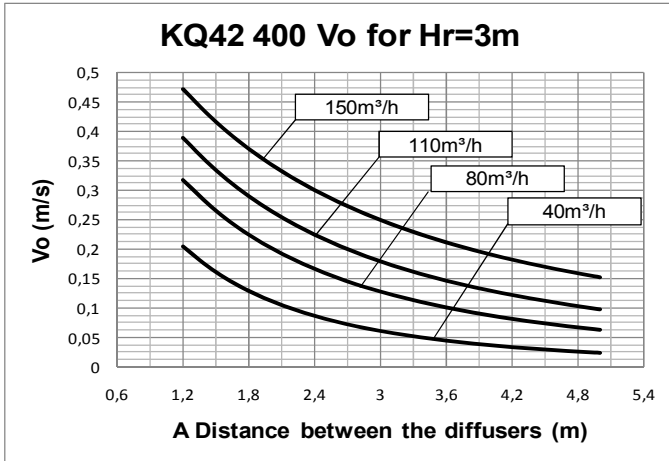

Data measured in isothermic conditions in accordance with international standards:
ISO 5219 1984: Air distribution and air diffusion - Laboratory. Aerodynamic testing and rating of air terminal devices.

A(m) distance between the diffusers
Vo (m/s) speed at the limit of the occupied zone
L (m) horizontal distance in metres from the centre of the diffuser
VL (m/s) maximum speed in the air stream

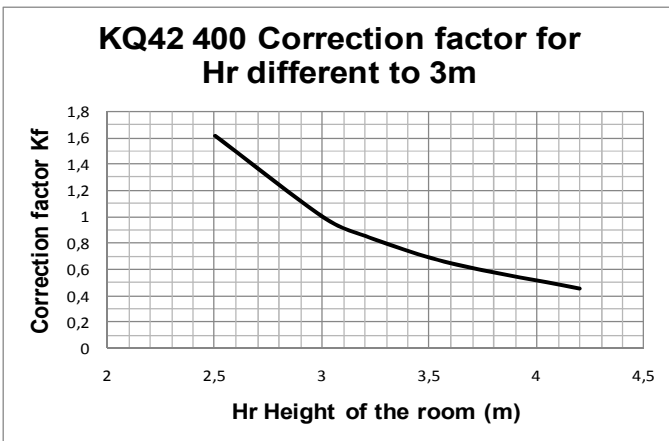

For Hr different from 3m:
 $V_o(h) = V_o \times K_f$

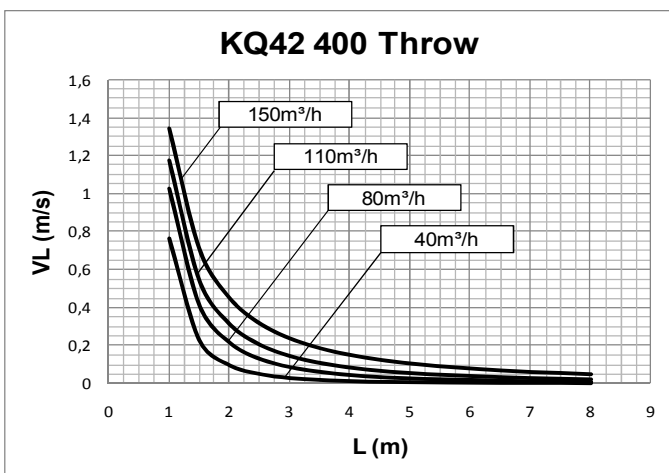



HIGH INDUCTION DIFFUSERS WITH VARIABLE GEOMETRY

KQ-42
SERIES

PERFORMANCE KQ42-400

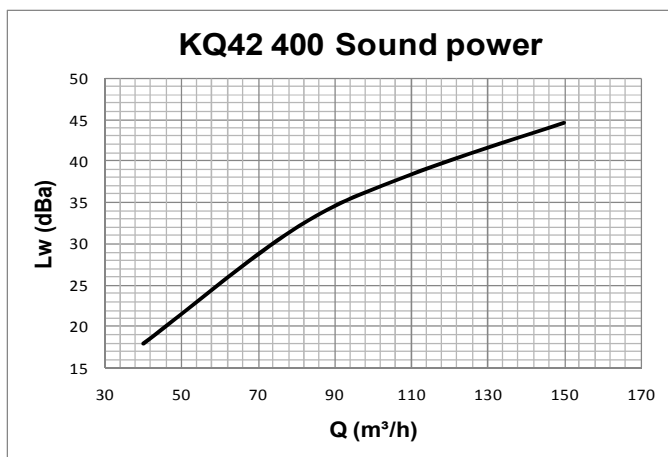

Data measured in reverberation room in accordance with international standards:

ISO 3741 1999: *Acoustic - determination of sound power levels of noise sources using sound pressure - Precision methods for reverberation rooms*

ISO 5135 1997: *Acoustic - determination of sound power levels of noise from air-terminal devices ; air terminal units; dampers and valves by measurement in a reverberation room.*

The data presented does not consider the attenuation given by the area of installation. This attenuation is normally between 6 and 10 dBA and is determined by the room size, the shape of the environment and the interior features.

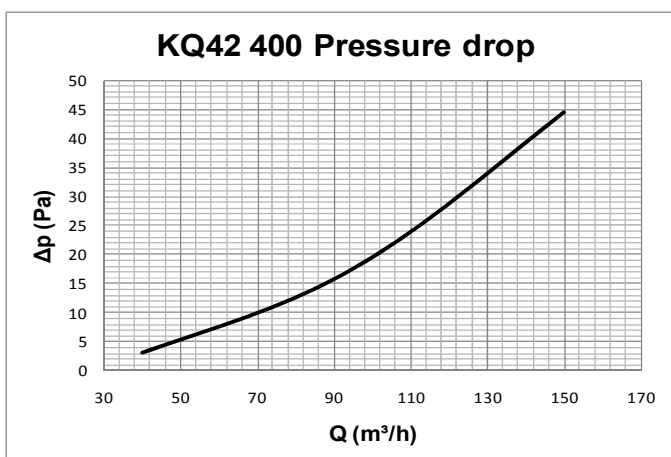

Data measured in isothermic conditions in accordance with international standards:

ISO 5219 1984: *Air distribution and air diffusion - Laboratory. Aerodynamic testing and rating of air terminal devices.*



HIGH INDUCTION DIFFUSERS WITH VARIABLE GEOMETRY

KQ-42
SERIES

PERFORMANCE KQ42-500
MULTIDIRECTIONAL THROW

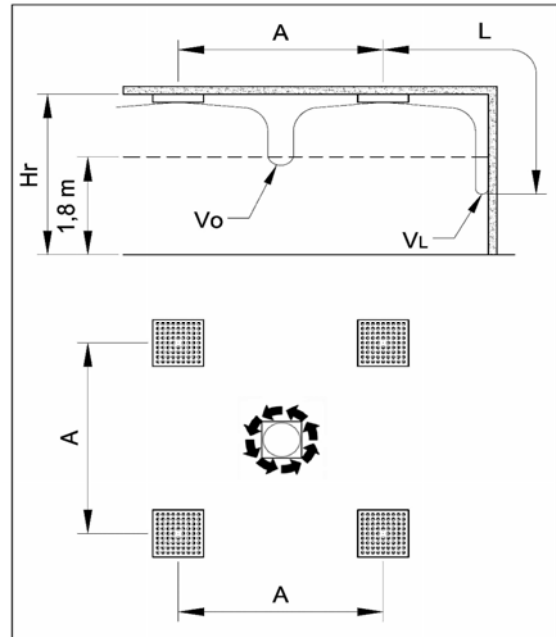
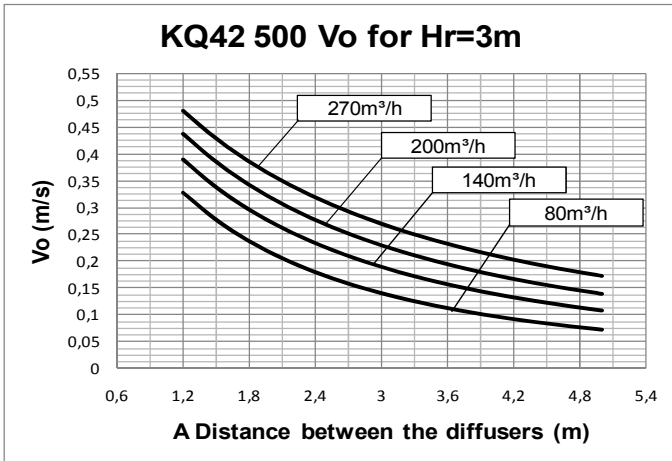

Data measured in isothermic conditions in accordance with international standards:
ISO 5219 1984: *Air distribution and air diffusion - Laboratory. Aerodynamic testing and rating of air terminal devices.*

A(m) distance between thwe diffusers
Vo (m/s) speed at the limit of the occupied zone
L (m) horizontal distance in metres from the centre of the diffuser
VL (m/s) maximum speed in the air stream

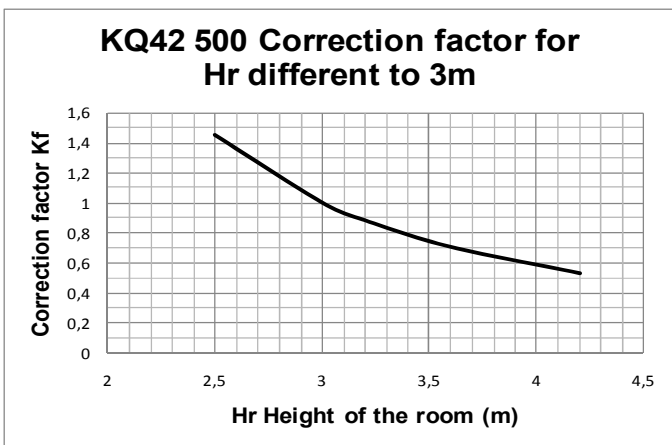

For Hr different from 3m:
 $V_o(h) = V_o \times K_f$

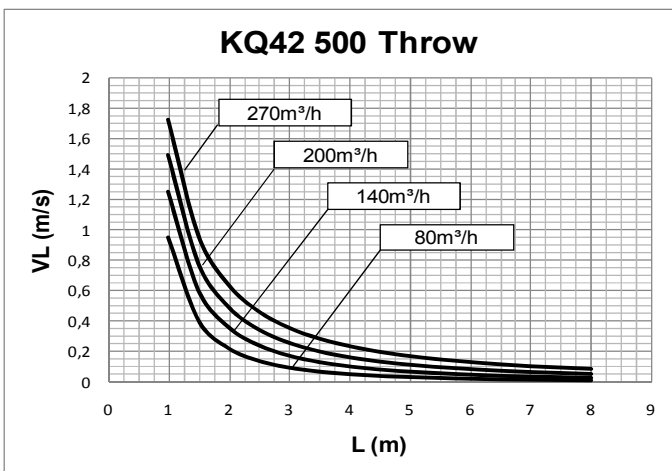



HIGH INDUCTION DIFFUSERS WITH VARIABLE GEOMETRY

KQ-42
SERIES

PERFORMANCE KQ42-500
SPIRAL THROW

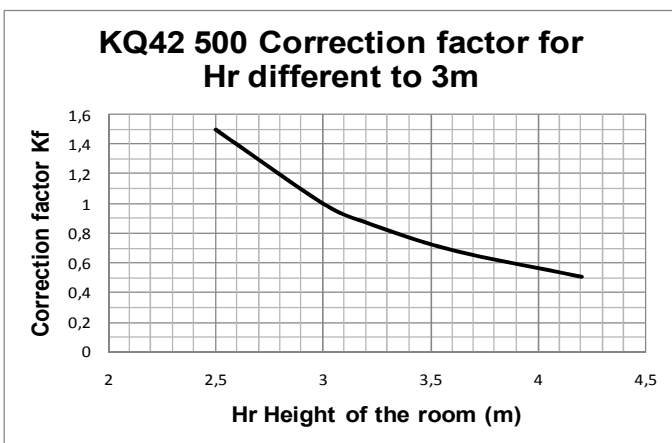
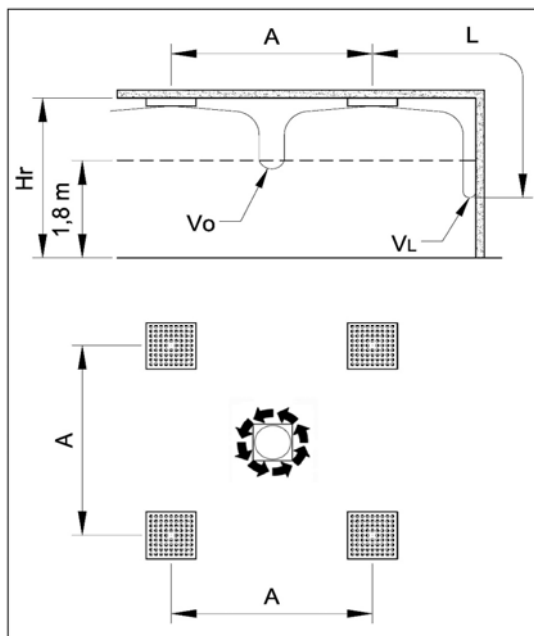
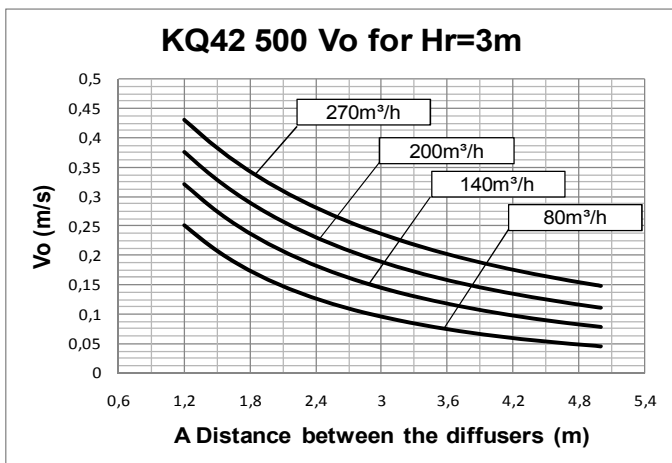

Data measured in isothermic conditions in accordance with international standards:
ISO 5219 1984: *Air distribution and air diffusion - Laboratory. Aerodynamic testing and rating of air terminal devices.*

A(m) distance between thwe diffusers
Vo (m/s) speed at the limit of the occupied zone
L (m) horizontal distance in metres from the centre of the diffuser
VL (m/s) maximum speed in the air stream

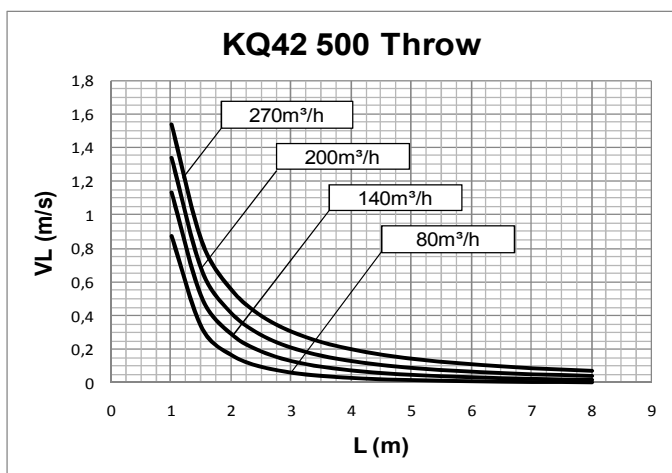

For Hr different from 3m:
 $V_o(h) = V_o \times K_f$



HIGH INDUCTION DIFFUSERS WITH VARIABLE GEOMETRY

KQ-42
SERIES

PERFORMANCE KQ42-600

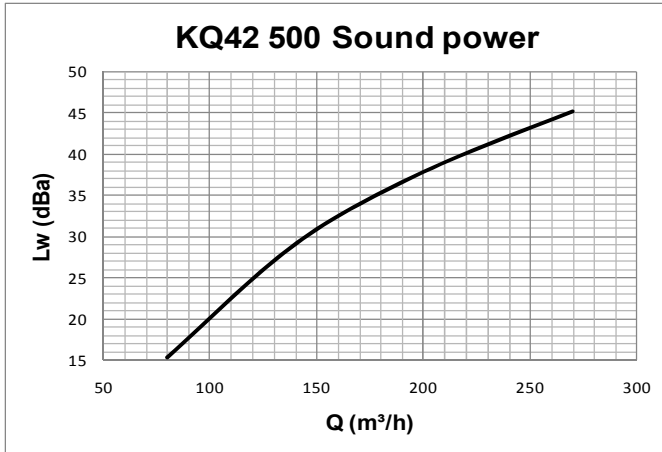

Data measured in reverberation room in accordance with international standards:

ISO 3741 1999: *Acoustic - determination of sound power levels of noise sources using sound pressure - Precision methods for reverberation rooms*

ISO 5135 1997: *Acoustic - determination of sound power levels of noise from air-terminal devices; air terminal units; dampers and valves by measurement in a reverberation room.*

The data presented does not consider the attenuation given by the area of installation. This attenuation is normally between 6 and 10 dBA and is determined by the room size, the shape of the environment and the interior features.

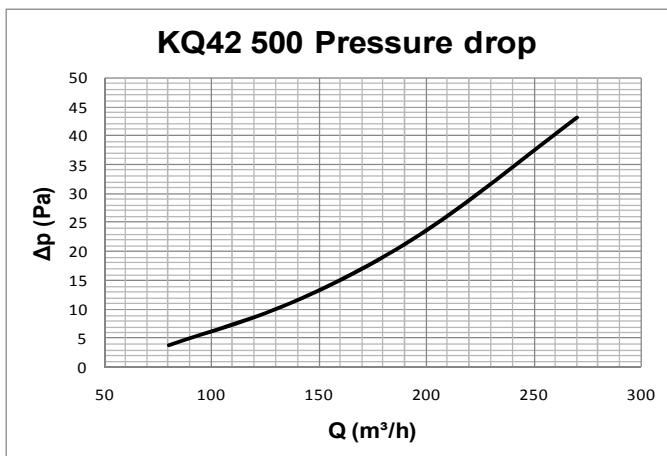

Data measured in isothermic conditions in accordance with international standards:

ISO 5219 1984: *Air distribution and air diffusion - Laboratory. Aerodynamic testing and rating of air terminal devices.*



HIGH INDUCTION DIFFUSERS WITH VARIABLE GEOMETRY

KQ-42
SERIES

PERFORMANCE KQ42-600/625
MULTIDIRECTIONAL THROW

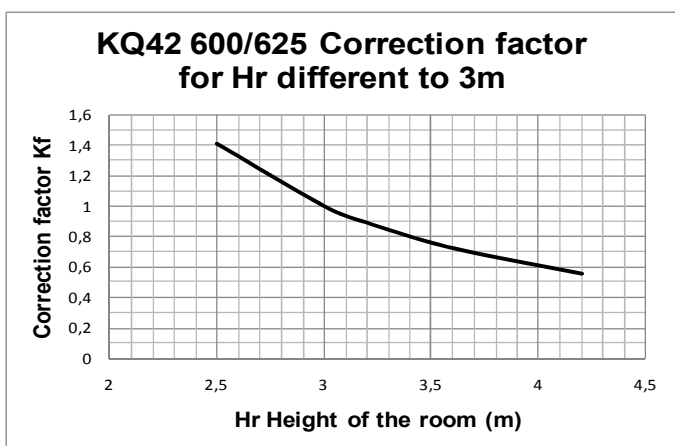
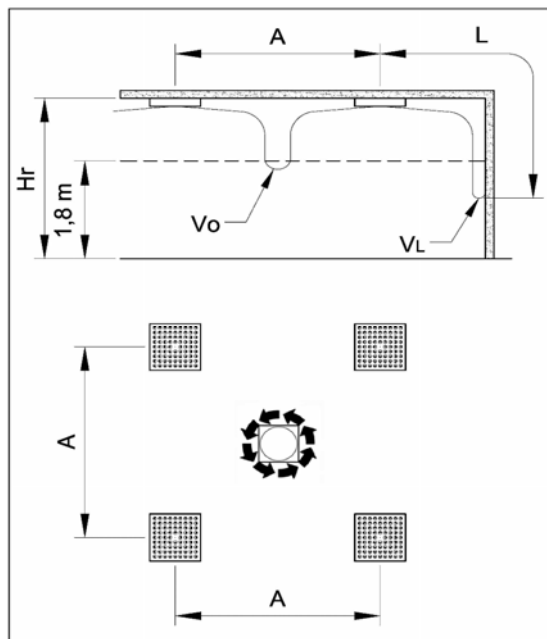
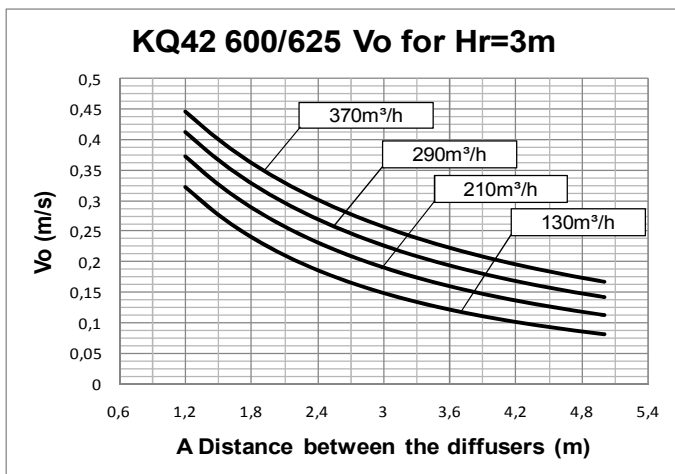

Data measured in isothermic conditions in accordance with international standards:
ISO 5219 1984: *Air distribution and air diffusion - Laboratory. Aerodynamic testing and rating of air terminal devices.*

A(m) distance between the diffusers
Vo (m/s) speed at the limit of the occupied zone
L (m) horizontal distance in metres from the centre of the diffuser
VL (m/s) maximum speed in the air stream

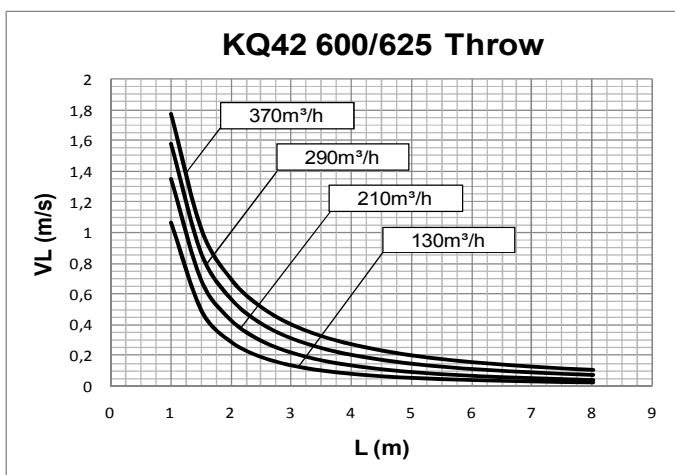

For Hr different from 3m:
 $V_o(h) = V_o \times K_f$



HIGH INDUCTION DIFFUSERS WITH VARIABLE GEOMETRY

KQ-42
SERIES

PERFORMANCE KQ42-500
SPIRAL THROW

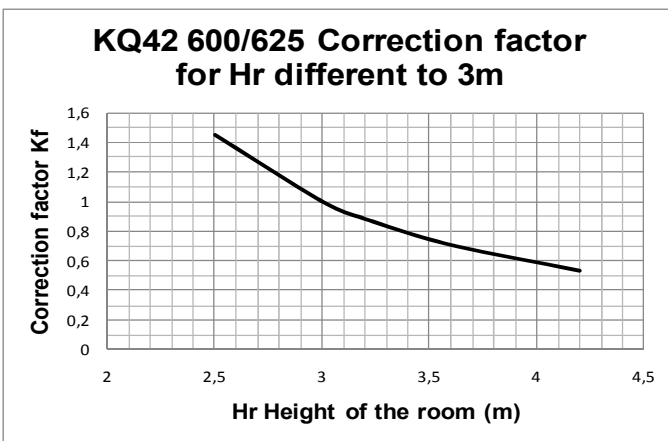
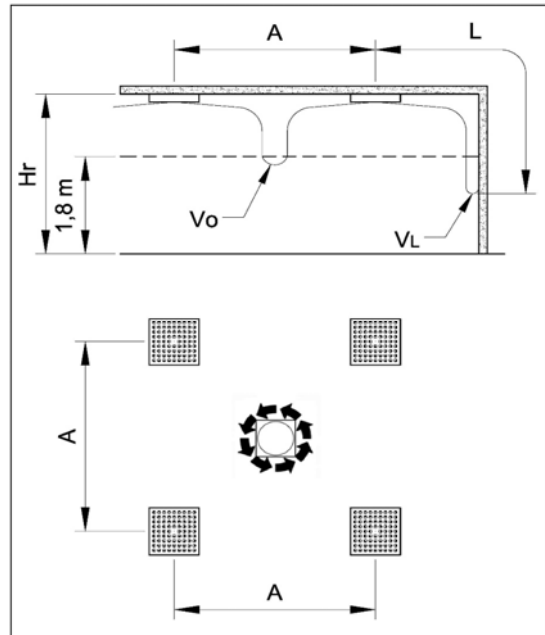
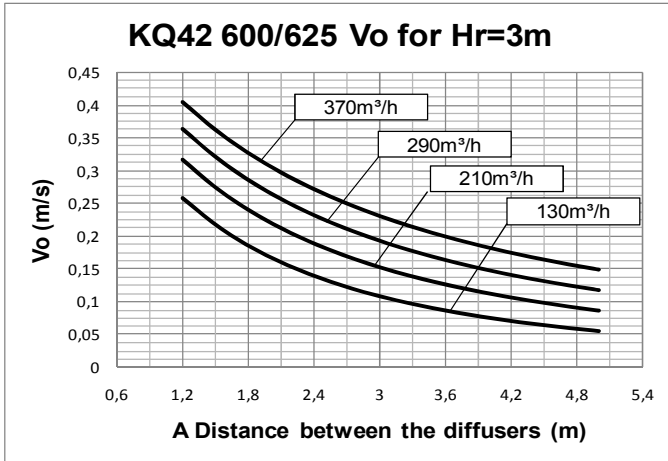

Data measured in isothermic conditions in accordance with international standards:
ISO 5219 1984: *Air distribution and air diffusion - Laboratory. Aerodynamic testing and rating of air terminal devices.*

A(m) distance between the diffusers
Vo (m/s) speed at the limit of the occupied zone
L (m) horizontal distance in metres from the centre of the diffuser
VL (m/s) maximum speed in the air stream

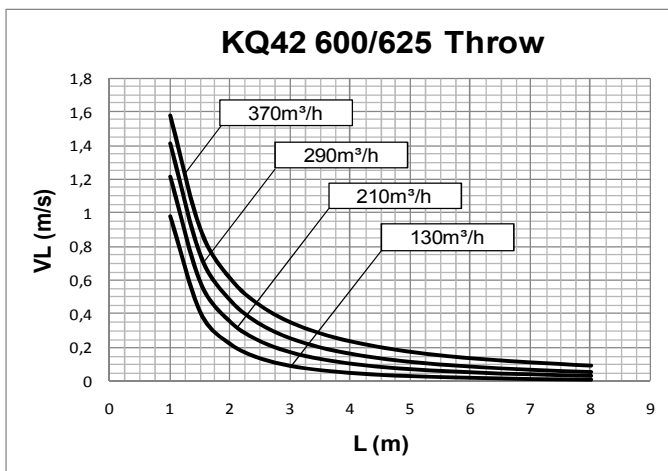

For Hr different from 3m:
 $V_o(h) = V_o \times K_f$



HIGH INDUCTION DIFFUSERS WITH VARIABLE GEOMETRY

KQ-42
SERIES

PERFORMANCE KQ42-600

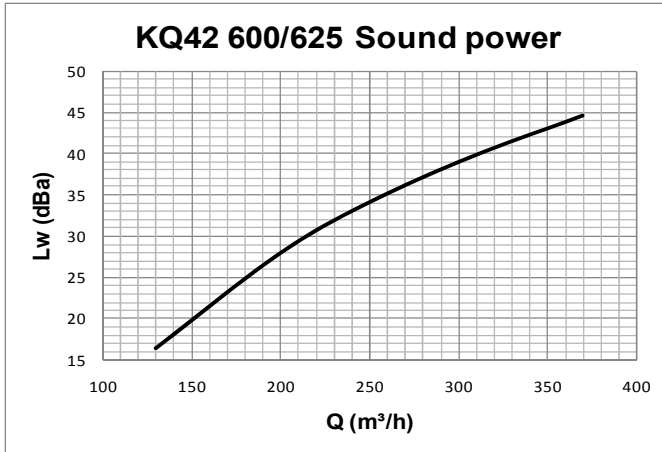

Data measured in reverberation room in accordance with international standards:
ISO 3741 1999: *Acoustic - determination of sound power levels of noise sources using sound pressure - Precision methods for reverberation rooms*

ISO 5135 1997: *Acoustic - determination of sound power levels of noise from air-terminal devices ; air terminal units; dampers and valves by measurement in a reverberation room.*

The data presented does not consider the attenuation given by the area of installation. This attenuation is normally between 6 and 10 dBA and is determined by the room size, the shape of the environment and the interior features.

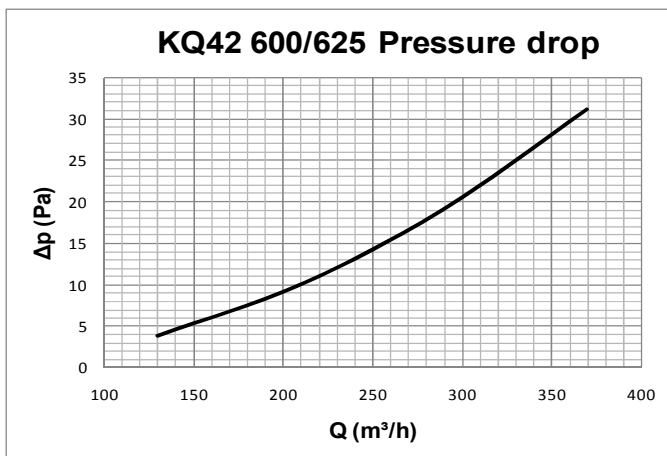

Data measured in isothermic conditions in accordance with international standards:
ISO 5219 1984: *Air distribution and air diffusion - Laboratory. Aerodynamic testing and rating of air terminal devices.*



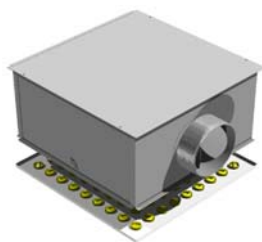

HIGH INDUCTION DIFFUSERS WITH VARIABLE GEOMETRY

PP80
PP81

PLENUM IN SEEL SHEET

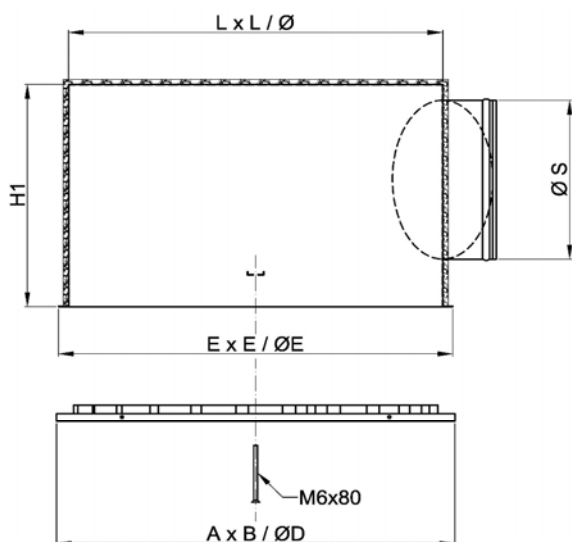

PLENUM PP80

Made of galvanized sheet steel.
Lateral connection.
Mounting bridge for mounting diffuser with central screw.
Complete with hooks for ceiling suspension.

optionals:
polyethylene insulation;
equalizer steel mesh;
control damper into the fitting.

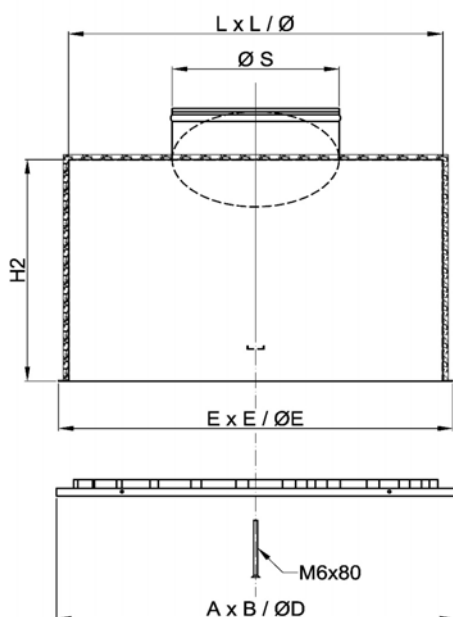

PLENUM PP81

Made of galvanized sheet steel.
Rear connection.
Mounting bridge for mounting diffuser with central screw.
Complete with hooks for ceiling suspension.

optionals:
polyethylene insulation;
equalizer steel mesh;
control damper into the fitting.

Nominal size of the diffuser	AxB ØD	L x L Ø	E x E ØE	H1	H2	N° connec- tions	S	Connection and damper material
300	296	260	290	250	150	1	123	ABS (*)
400	396	360	390	350	200	1	195	ABS (*)
500	496	460	490	350	200	1	195	ABS (*)
600	596	560	590	350	200	1	245	ABS (*)
625	621	585	615	350	200	1	245	ABS (*)
800	796	760	790	400	250	1	296	steel
825	821	785	815	400	250	1	296	steel

(*) Steel on request



HIGH INDUCTION DIFFUSERS WITH VARIABLE GEOMETRY

PP80
PP81

PLENUM IN SEEL SHEET

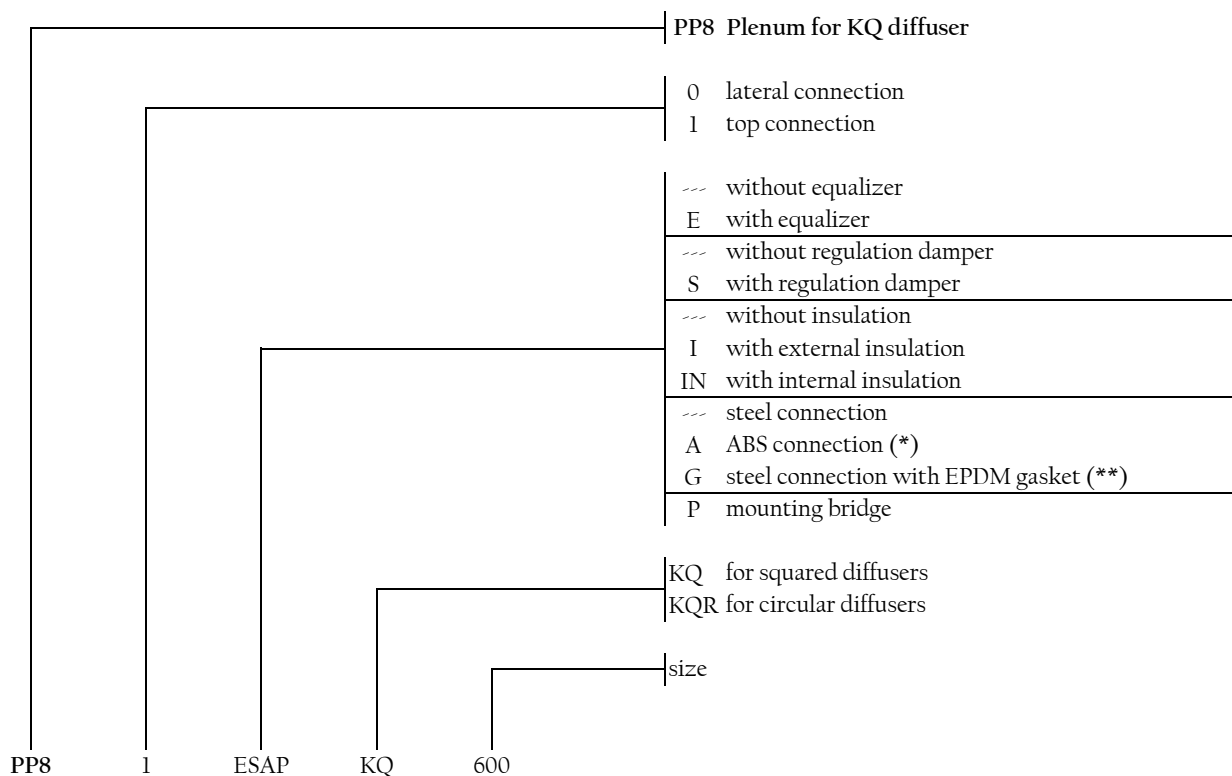

(*) Available in diameters 123mm 195mm 245mm

(**) Special execution

Standard sizes
200
300
400
500
600
625
800
825



PS PLENUM

PPS SERIES

OVERVIEW

OVERVIEW :

The PPS series of polystyrene assemblable plenum boxes have a density of 45 kg/m³, with a Fire class 1 quality, eternally crystallised.

The transformation process and the special properties of the material, make the PPS a very compact and lightweight plenum.

These special features combined to the trapezoidal shape that distinguish it, allows the fixing of the unit in completed countersealing structure. This facilitates both the realisation and maintenance of the system. Given the light weight, the plenum is positioned on the structure of the counter ceiling, eliminating therefore the necessity of using hanging clips for fixing to the ceiling.

This has the advantage of reducing considerably the fitting time and a saving of the space used of over 50%, compared to a traditional plenum box.

The PPS has an excellent thermal acoustic insulation characteristic. It does not therefore require additional insulating material.

The PPS plenums can be supplied already assembled with a square 600x60mm diffuser panel , model KQ1, complete with regulation damper in ABS and equalizer, ready for installation.

As an alternative, there is also a version assembled but without the diffuser fitted.

Lastly a kit is also available, comprising the plenum, the connection "C", bar "A" and assembly diagram.

Installation: once the diffuser has been fitted to the plenum using the screw "V" (PPS-V680T) to bar "A", the plenum is positioned on the counter ceiling structure.

TECHNICAL CHARACTERISTICS:

fire reaction:
Class 1 - Test report CSI DC01/378F05.
Euroclass E - Test report CSI DC01/656F07

Mechanic resistance:
10% deformation with 226kPa pressure - Test report CSI 0936/FPM/MATs/07.

Water absorption:
Increase average volume 3,26% in full immersion, tested according to UNI EN 12087 method 2A - Test report CSI 0936/FPM/MATs/07_2.

Thermal conductivity:
 Δ (average) 0,0320 W/mK - Test report CSI 0037/DC/TTS/07.

Thermal resistance:
R (average) 0.637 m²K/W- Test report CSI 0037/DC/TTS/07.

Test certificate type:
Certificate CSI DE/1831/07 issued in conformity to directive 89/106/CEE on the basis of UNI EN 13163/2003 and UNI EN 13172/2003.

The documentation indicated above can viewed in electronic form in Italian with prior agreement from the Technical Department.

ASSEMBLED PPS

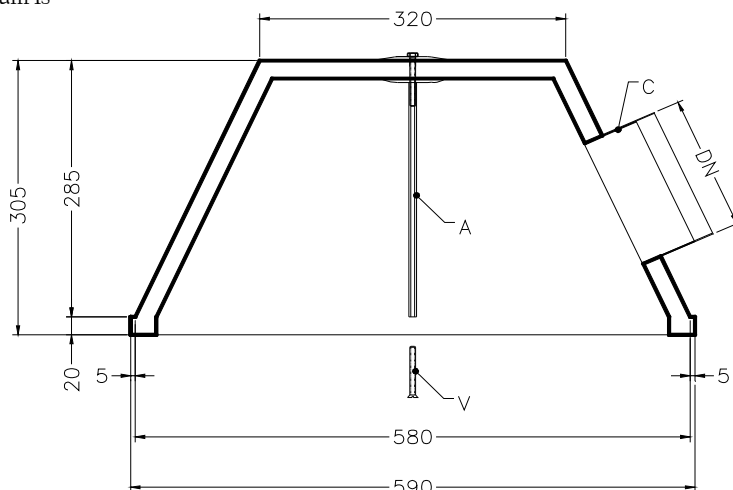



PS PLENUM

OVERVIEW

PPS SERIES

Image	Description	Connector diameter	Code
	Plenum in PS already assembled with connector in ABS with damper and without equalizer.	125	PPS-PS125
		160	PPS-PS160
		200	PPS-PS200
		250	PPS-PS250
	Plenum in PS already assembled, complete with connector in ABS with damper and equalizer.	125	PPS-PES125
		160	PPS-PES160
		200	PPS-PES200
		250	PPS-PES250
	Plenum in PS already assembled, complete with connector in ABS with damper, equalizer and diffuser KQI 600.	125	PPS-KQIPES125
		160	PPS-KQIPES160
		200	PPS-KQIPES200
		250	PPS-KQIPES250

ACCESSORIES

	Only PS bell shape body with fixing bar (without connector)		PPS-KIT
	Equalizer for plenum		PPS-E
	Connector in ABS	125	RR10-125
		160	RR10-160
		200	RR10-200
		250	RR10-250
	Damper for connectors in ABS	125	RRS10-125
		160	RRS10-160
		200	RRS10-200
		250	RRS10-250
	Fixing screw (usually already included in the DIFFUSER)		PPS-V680T